

SAS 32KD
AUDIO ROUTING NETWORK
Installation and User Manual



Proprietary Notice

This document contains proprietary information which may not be disclosed to others or used in manufacturing, or any other purpose, without written permission from Sierra Automated Systems & Engineering Corporation. The information and design disclosed herein were originated by and are the property of Sierra Automated Systems & Engineering Corporation. All patent, proprietary design, manufacturing, reproduction, use and sales rights are reserved except where those rights are expressly granted to others.

Copyright Notice

Copyright 1999 by Sierra Automated Systems & Engineering Corporation, Burbank, California, USA. All rights reserved. Reproduction in whole or in part without prior written permission from Sierra Automated Systems & Engineering Corporation is prohibited.

Service Manual for SAS 32KD Stereo Audio Routing Switcher

Revision: 1

This manual is published by the Engineering Department of Sierra Automated Systems & Engineering Corporation, which is responsible for its contents. Address all communication regarding this publication to:

Director of Engineering
Sierra Automated Systems & Engineering Corporation
2821 Burton Avenue
Burbank, California 91504
USA
Tel (818) 840-6749 Fax (818) 840-6751 www.sasaudio.com

Limited Warranty

The products of Sierra Automated Systems & Engineering Corporation are warranted to be free from defects in materials and workmanship for a period of one year from the date of sale.

Sierra Automated Systems & Engineering Corporation's sole obligation during the warranty period is to provide, without charge, parts and labor necessary to remedy covered defects appearing in products returned prepaid to Sierra Automated Systems & Engineering Corporation, 2625 North San Fernando Road., Burbank, California, 91504, U.S.A.. This warranty does not cover any defect, malfunction or failure caused beyond the control of Sierra Automated Systems & Engineering Corporation, including unreasonable or negligent operation, abuse, accident, failure to follow instructions in the Technical Manual or the Owner's Manual, defective or improper associated equipment, attempts at modification and repair not authorized by Sierra Automated Systems & Engineering Corporation, and shipping damage. Products with their serial numbers removed or effaced are not covered by this warranty.

This warranty is the sole and exclusive express warranty given with respect to Sierra Automated Systems & Engineering Corporation products. It is the responsibility of the user to determine before purchase that this product is suitable for the user's intended purpose.

ANY AND ALL IMPLIED WARRANTIES, INCLUDING THE IMPLIED WARRANTY OF MERCHANTABILITY ARE LIMITED TO THE DURATION OF THIS EXPRESS LIMITED WARRANTY.

SIERRA AUTOMATED SYSTEMS & ENGINEERING CORPORATION IS NOT LIABLE FOR INCIDENTAL OR CONSEQUENTIAL DAMAGES OF ANY KIND.



SAS 32KD Audio Routing Network

Table of Contents.

Description	4
Main Frame Description	4
User Connection Modules.....	5
Connecting the Router Control Software Computer (RCS computer).....	5
KAI-16 Analog Input Module Description	6
KDI-16 Digital Input Module Description.....	7
KAO-16 Analog Output Module Description.....	8
KDO-16 AES Output Module Description	9
KRL-16 RIO Link Module Description	10
RIO Link Chassis Description	11
DRC-16 Serial Control Port Description.	11
RIO Chassis Analog Signal Connector Terminal/Pin Assignment (Input and Output)	12
RIO Chassis Digital (AES) Signal Connector Terminal/Pin Assignment (Input and Output).....	13
RIO Chassis RS-485 Control Port Connector Terminal/Pin Assignment	14
RIO Chassis Relay Connector Terminal/Pin Assignment.....	15
RIO Chassis Opto Isolated Inputs Connector Terminal/Pin Assignment.....	16
EURO Connector Pin Detail for Analog I/O.....	17
EURO Connector Pin Detail for Digital I/O	18
EURO Connector Pin Detail for RS-485 Ports	19
EURO Connector Pin Detail for MCU-32E.....	20
Typical Application.....	21
SAS 32KD Startup Wiring Guide	22
SAS Standard Block Wiring Digital In/Out.....	23
SAS Standard Block Wiring Analog In/Out	24
External AES/Clock Input	25
Typical Configuration	26
Frame Module Installation.	26
Stereo and Mono Mode Programming.	27
INPUT Channel Alpha and Link Programming Window.	27
OUTPUT Channel Alpha and Link Programming Window.	27
Stereo and Mono Mode Programming.	28
Typical Configuration Example for Destination Channels.	28
Typical Configuration Example for Source Channels.....	28
Typical Crosspoint Map Display.	29
SAS Control Panel Wiring Detail	30
SAS Control Panel Configuration/Assignment.....	31
SAS Control Panel Configuration Expanded Addressing (to 8)	32
GPI 1600 Opto/Relay Control Panel	33
Connecting the GPI-1600.....	33
GPI-1600 Opto/Relay Programming.....	34
Intercom and IFB Feature	36
RCS-16 Control Panel Wiring	36
APC-88 Control Panel Wiring for Intercom	37
Intercom Station Programming	38
Button Templates and Programming.....	39



SAS 32KD Digital Audio Network

PRELIMINARY

Description

The SAS 32KD is large scale digital audio network switching system housed in a 6 rack unit frame that contains all audio signal modules, frame controller and multi-port RS-485 controller modules. The system provides dual backup power supplies with separate AC line cords to allow a greater level of redundancy. The frame is universal in that any slot can be fitted with audio input modules, audio output modules and required controller modules. The frame provides up to 512 audio signal connections using a passive connector module installed from the rear of the frame. The connector module contains no electronic components and a variety of connector types can be optionally selected for audio inputs, outputs and controllers. The connector modules are available with EURO (32 analog signal SAS standard connector), RJ21/45 (RJ-21 - 50 pin telco ribbon for 16 signal circuits plus RJ-45 for Ethernet or RS-232/485), and dual DB25 (computer D sub, 8 signal circuits each, 16 circuits total).

The frame can be populated with any compliment of audio input modules (analog or digital), audio output modules (analog or digital), and required number of RS-485 control ports suitable for connection to all SAS standard alphanumeric/pushbutton router or intercom control panels.

The modular audio signal modules are available in analog or digital as follows:

KAI-16 provides 16 stereo analog audio inputs

KAO-16 provides 16 stereo analog outputs

KDI-16 provides 16 AES/EBU inputs

KDO-16 provides 16 AES/EBU outputs

The system allows any combination of inputs sources to be mapped (switched or mixed) to any output. The system provides many control options ranging from front panel manual selection using a wide variety of alpha numeric control panels, to full automation using the SAS Routing Control Software or automation serial control ports. The system provides summing and mixing of audio sources to any output suitable for building mix minus feeds and other mixing applications.

Main Frame Description

The Frame provides 21 universal slots. For ease of documentation and comprehension, especially in multi-frame systems, SAS recommends reserving the leftmost slots 1 to 16 for audio or other signal I/O modules and the rightmost 5 slots 17 to 21 for control and network modules: Frame Controllers, Remote Control Modules, and Audio Network Interface. The system requires at least 1 MCU-32 Frame controller which supplies system clock on two separate clock busses. An optional second MCU-32 module can be installed and will automatically provide backup system clock and other communication functions for greater redundancy. A and B clock busses provide an additional level of fault tolerance - if the integrity of the clock bus is uncertain, each module will automatically switch to the alternate clock bus.

User Connection Modules

User Connection Modules allow signal connections to the mainframe. A connection module is installed into the rear of the frame for each audio module (input or output) and controller module. The connection module does not contain active or passive electronic components which eliminates the need for servicing once installed. Analog signal modules require the EURO connector module which provides 32 audio signal connections (16 Stereo analog), while the digital signal modules can optionally be fitted with EURO connector modules (upper 16 signals used only) or RJ21 connector modules (25 pair telco ribbon provides 16 signal and 8 ground pairs).

Connecting the Router Control Software Computer (RCS computer)

The system is configured using the RCS^{win} software provided on CD ROM with the system. The computer is for configuration only and is not required for the system to operate. System programming such as source and destination names, serial RS-485 port assignments and push button programming is accomplished using the RCS software. The complete mapping and all system configuration programming is stored in non-volatile memory on board the MCU-32 Frame Controller module and will be automatically restored after any power disruption.

MCU-32 EURO Connector

Computer RS-232 Port

C3 (RS-232 Tx)-----	Pin 2 DB 9 Rx / Pin 3 DB 25 Rx
B3 (RS-232 Rx)-----	Pin 3 DB 9 Tx / Pin 2 DB 25 Tx
A3 (RS-232 Gnd)-----	Pin 5 DB 9 Gnd/ Pin 7 DB 25 Gnd

The software will query the system and learn the type of module that has been installed in the frame. The software will chronologically assign input and output channel numbers if desired, or the channels may be assigned and locked down manually at any time. Once set up, (and inputs and outputs are wired accordingly), this configuration is stored and will not have to be modified until the system grows.

For quick startup wiring information refer to page 20.

SAS 32KD

Front View



Rear View



KAI-16 Analog Input Module Description

The KAI-16 Analog Input Module provides 16 Stereo Audio Inputs (32 mono channels) into the system. The module digitizes signals using full linear 24 bit A/D conversion at 48K sampling rate. Each module feeds a 32 channel TDM serial buss which corresponds to the frame slot. This allows hot swap-ability without disrupting audio signals from other modules within the system.

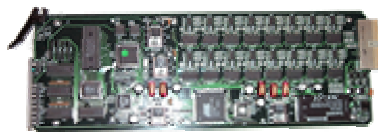

**KAI-16
32 Ch. Input Module**

**KAI-16
Block Diagram**

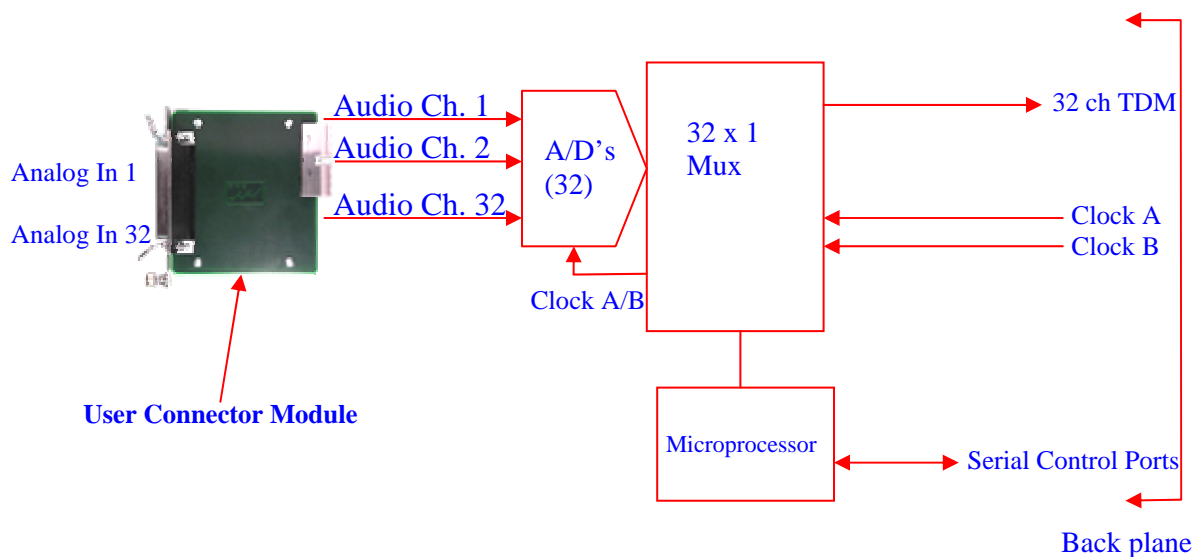

SAS 32KD

Front View

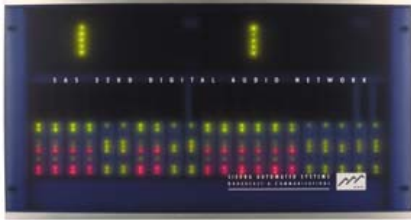

Rear View

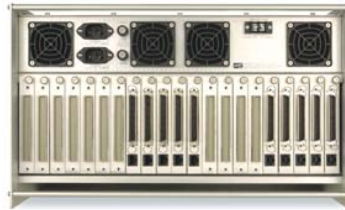

KDI-16 Digital Input Module Description

The KDI-16 Digital Input Module provides 16 AES/EBU Inputs (32 mono channels) into the system. The module receives the AES encoded audio data and separates it into 2 individual channels. A high performance sample rate converter re-clocks the data into an internally timed bitstream and then is encoded onto a single 32 channel TDM serial bus. Each module feeds a 32 channel TDM serial bus which corresponds to the frame slot. This allows hot swap-ability without disrupting audio signals from other modules within the system.

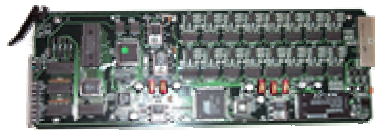

KDI-16
16 AES/EBU Inputs

KDI-16
Block Diagram

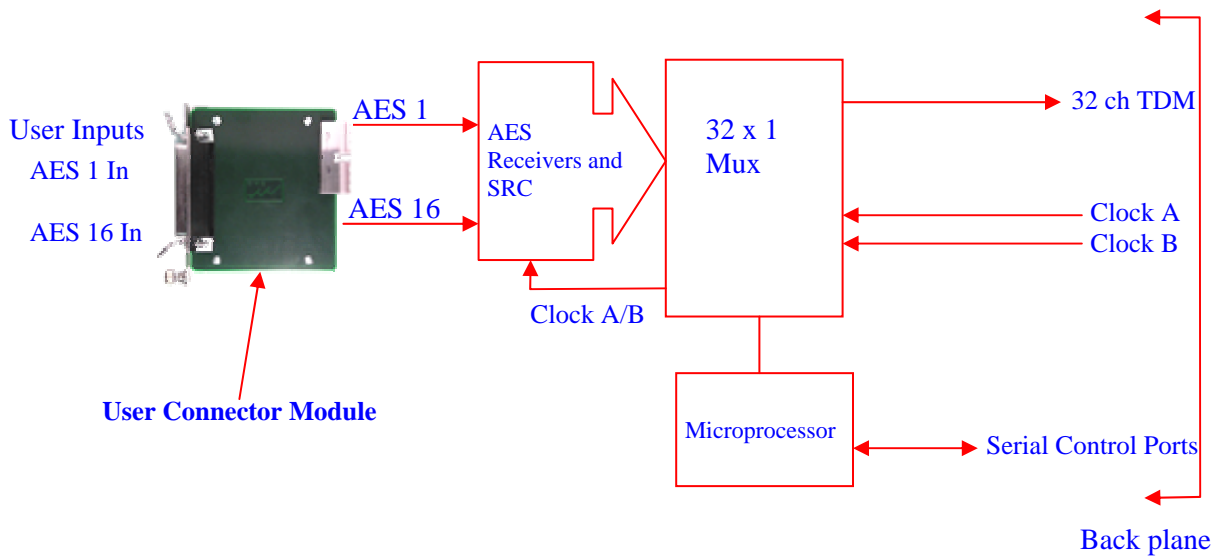

KAO-16 Analog Output Module Description

The KAO-16 Analog Output module provides 16 Stereo Audio Outputs (32 mono channels) from the system. The module provides selection of 32 channels from the 1024 channels on the backplane: 16 serial 32 channel TDM busses of internal sources (512 total possible from input modules within the frame) and 16 serial 32 channel TDM busses of sources that are received from external frames through the Audio Network Interface module (512 total possible from network modules for multi-frame systems). The KAO-16 utilizes full 24 bit linear D/A conversion that provides a nominal 110 dB dynamic range. An on-board DSP processor allows functions such as mixing and level control to 32 additional outputs that are re-entered into the frame on the slots corresponding TDM input bus. This allows processed audio to be available to other outputs within the system, in addition to the outputs on the module for customized applications.

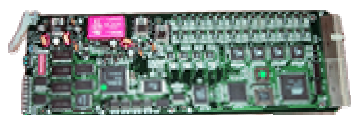

**KAO-16
32 Ch. Output Module**

KAO-16 Block Diagram

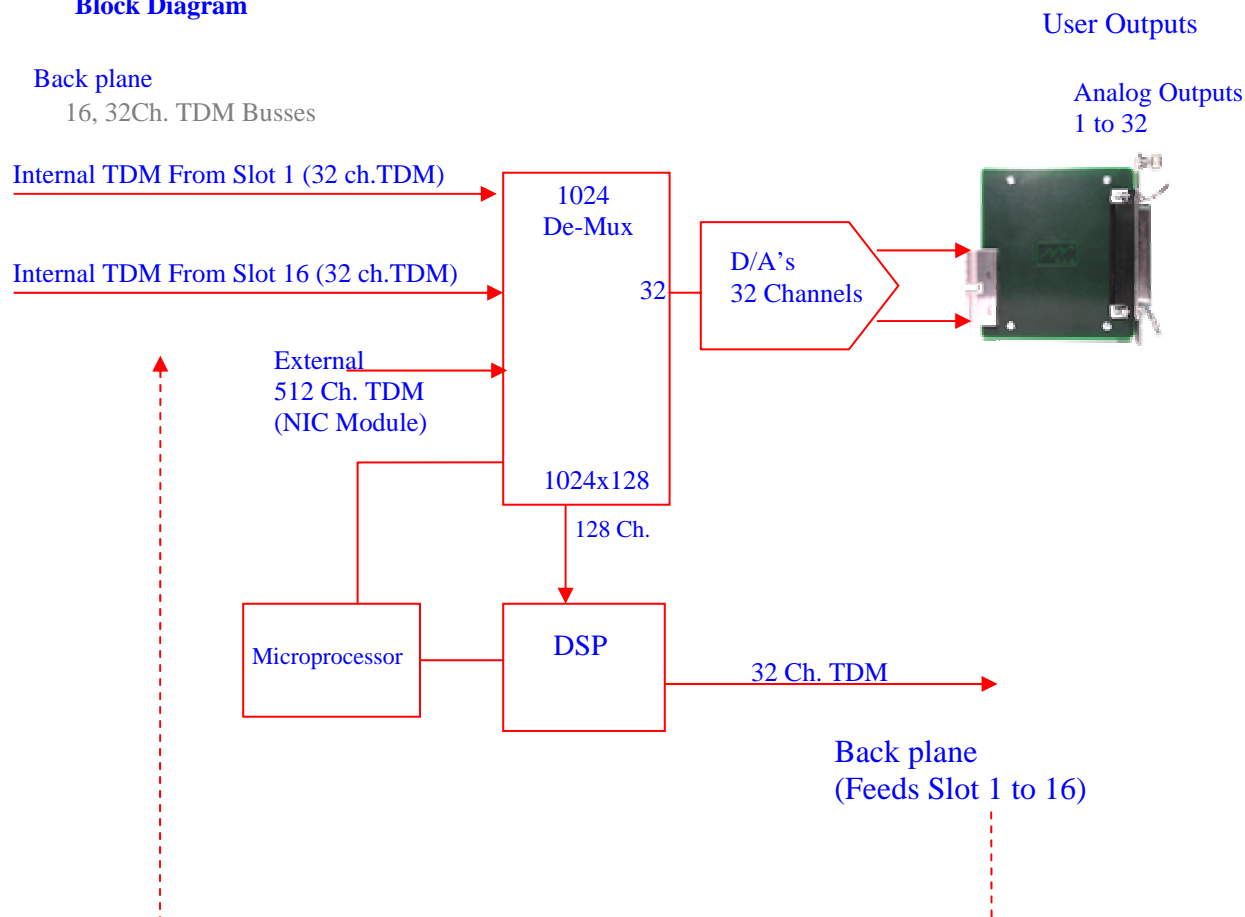

KDO-16 AES Output Module Description

The KDO-16 Digital AES Output module provides 16 Stereo AES Outputs (32 mono channels) from the system. The module provides selection of 32 channels from the 1024 channels on the backplane: 16 serial 32 channel TDM busses of internal sources (512 total possible from input modules within the frame) and 16 serial 32 channel TDM busses of sources that are received from external frames through the Audio Network Interface module (512 total possible from network modules for multi-frame systems). The KDO-16 allows any 2 input channels to be mapped to the A and B channels of the AES data signal to allow a 2 channel mono or Left and Right Stereo.

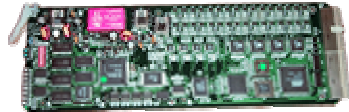

**KDO-16
32 Ch. Output Module**

KDO-16 Block Diagram

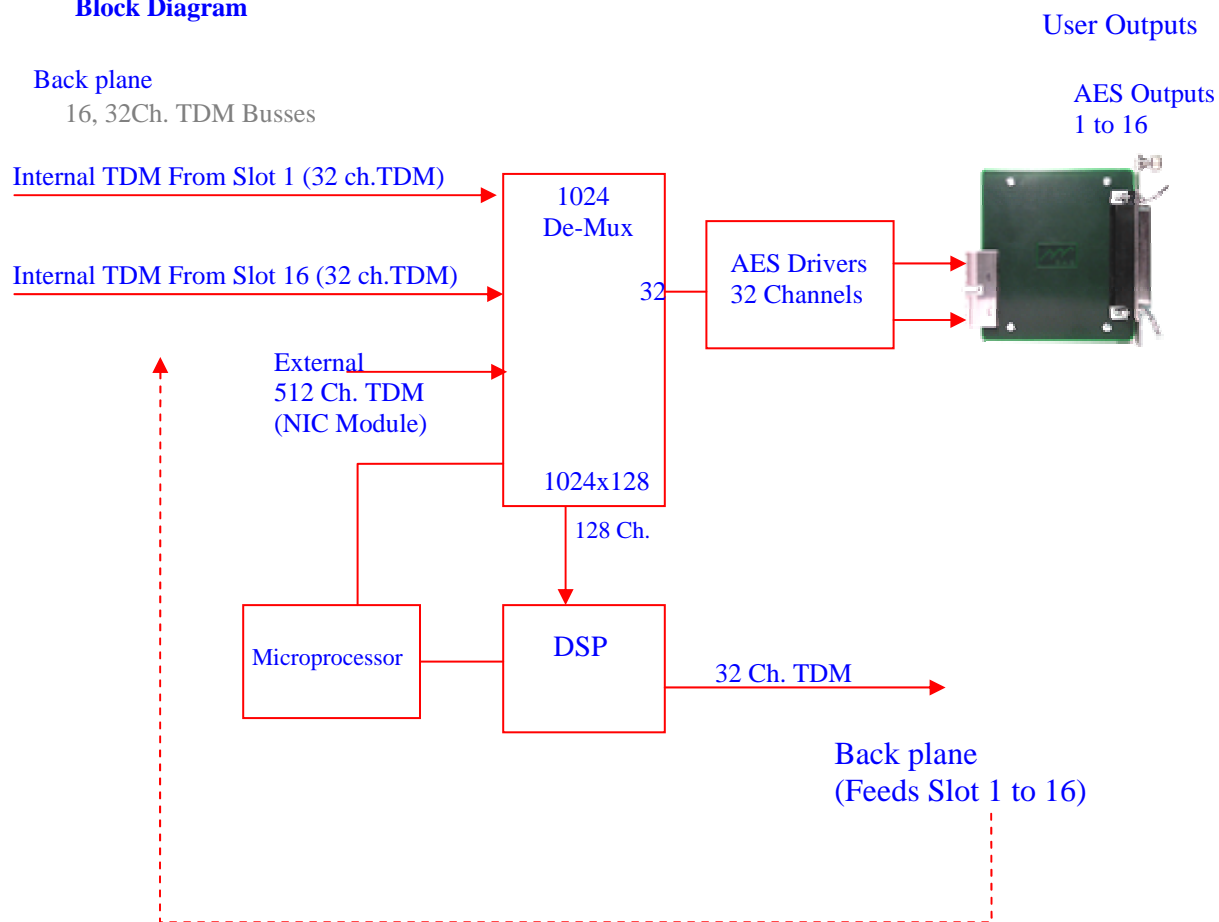

KRL-16 RIO Link Module Description

The KRL-16 module provides 32 channels into the system and 32 channels out. The IO module allows a 32 channel multi-audio signal, and 16 RS-485 standard SAS control channels to be delivered “to and from” a RIO Link Chassis across a CAT V or Fiber connection. The RIO Link Chassis is a 2 RU self-contained interface that is suitable to be installed into a control room, studio or other remote location and utilizes RJ-21 (50 pin telephone type) connectors for signal interconnection. A standard telephone type CAT V cable terminated with 50 RJ-21 connectors can be used to quickly wire to a punch block with an RJ-21 connector (option) installed on the side. A corresponding RIO connector module is installed into the rear of the frame that houses an RJ45 standard CATV connector and an optional fiber plug in element. When using CAT V cabling, the fiber elements must not be installed.

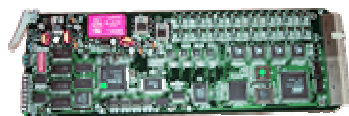

KRL-16
32 Ch. Input/Output module

KRL-16 Block Diagram

Back plane

16, 32Ch. TDM Busses

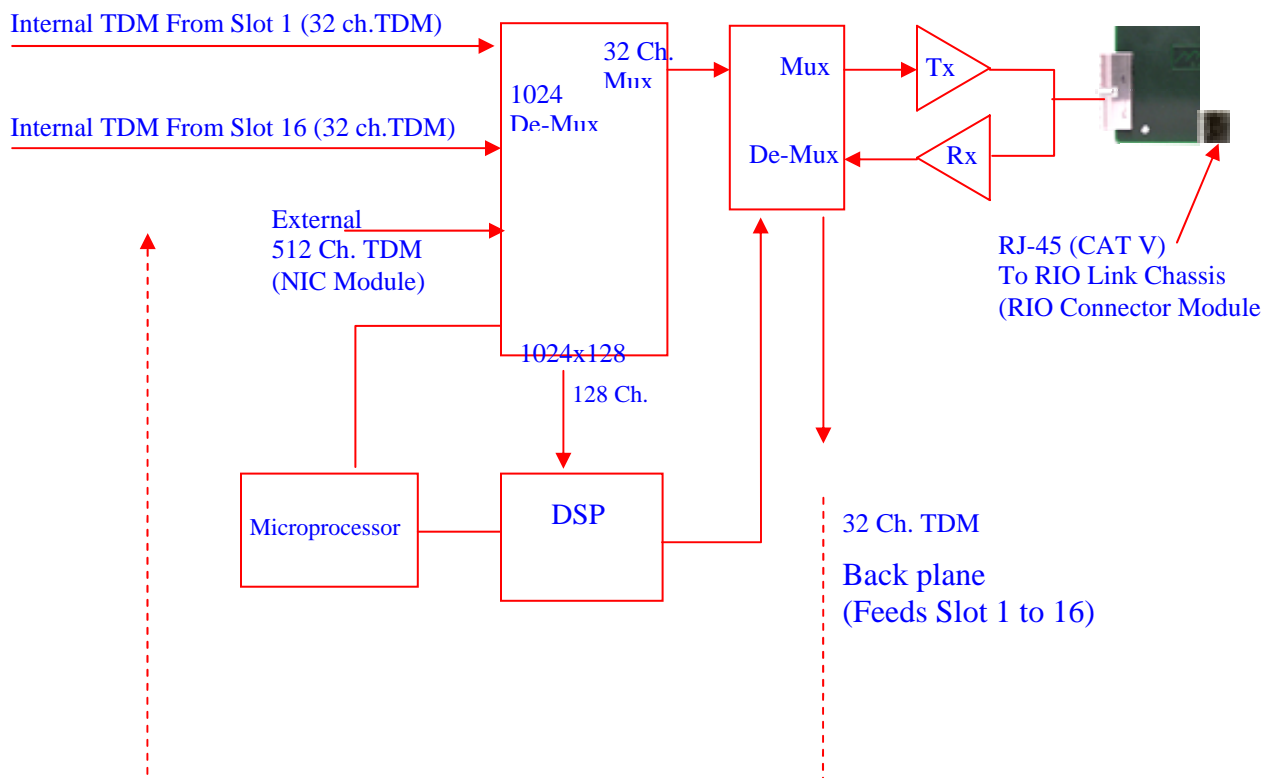

RIO Link Chassis Description

The RIO Link Chassis is a 2 RU chassis that can be remotely located up to 600 feet using CAT V standard network (LAN) cable, or longer using the fiber option. The fiber option are plug in connector elements that install into the rear of the mainframe, and chassis. The chassis connects to the mainframe as shown below. "LINK" indicator LED's on the front of the KRL-16 mainframe module and front of the RIO Link Chassis will turn to green (from Red) when the link (CAT V or Fiber) connection is established.

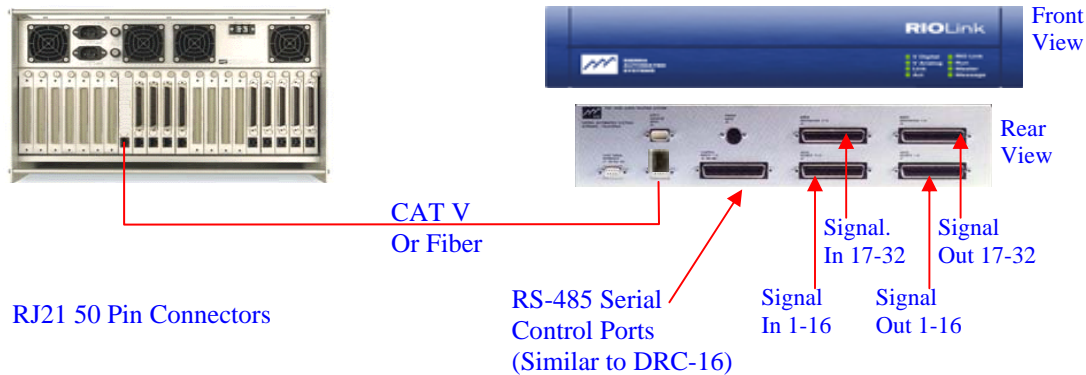

Audio inputs and outputs are connected to the remote RIO Link chassis utilizing standard RJ-21 telephone type connectors. Each connector provides 16 channels of audio and can optionally be fitted with analog or digital interconnect modules. Any combination of digital/analog inputs and outputs is allowed. When the chassis is fitted with a digital I/O type connector module only the first eight (8) signal connections are used. A standard 50 pin (25 pair) CAT V telephone cable can be used to connect directly to a punch block housing a 50 pin connector on the side. The terminal pin out of the block is as follows.

DRC-16 Serial Control Port Description.

The DRC-16 module for the SAS 32KD is a controller module that provides 16 RS-485 serial ports and 5 RS-232 serial ports. The RS-485 ports can be configured individually to allow operation from XY or SOC (single output control) type SAS alpha numeric controllers or AUTOMATION, or connection to GPI-1600 relay controllers, and Intercom full function control panels. Each RS-485 port can be programmed to allow up to 4 controllers of the same type (i.e. XY, SOC, Intercom) utilizing an addressing technique. The address of each individual control panel is determined by a jumper on the System RS-485 DB9 mating connector. Utilizing address pins on the mating connector allows controller plug and play interchangeability without having to set switches or jumpers on the controller hardware itself. The 5 RS-232 serial ports are configured for standard USI (user serial interface) protocol suitable for connection to digital audio delivery systems, or other automation type computers.

RIO Chassis Analog Signal Connector Terminal/Pin Assignment (Input and Output)

The RIO Chassis connector for Analog Signals is designed to connect directly to a standard 50 pin terminal block such as the 66 or Krone that has an RJ21 connector option. Utilizing off the shelf telephone CAT V, and telephone block, the terminal block pin detail is as follows.

Standard Punch Block with
50 Pin RJ21 on the Side.

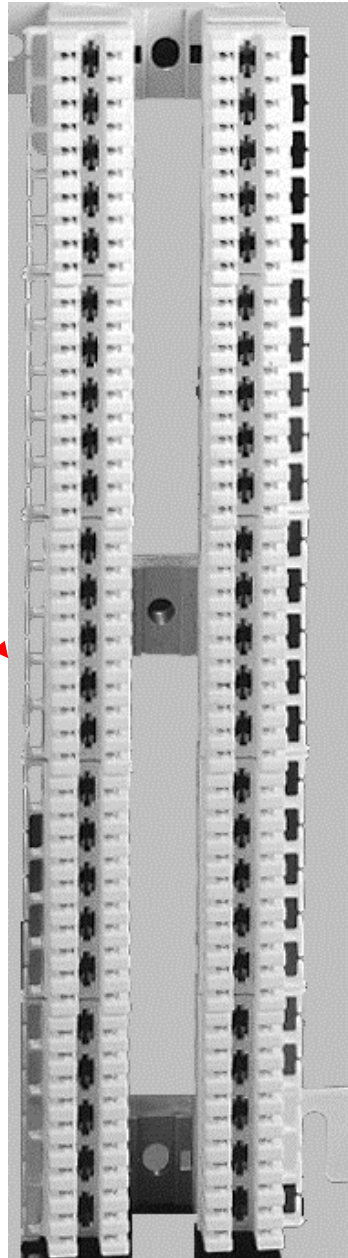

- 1 - Common
- 2 - Common
- 3 - Signal Audio + RIO Channel 1 or 17
- 4 - Signal Audio - RIO Channel 1 or 17
- 5 - Signal Audio + RIO Channel 2 or 18
- 6 - Signal Audio - RIO Channel 2 or 18
- 7 - Common
- 8 - Common
- 9 - Signal Audio + RIO Channel 3 or 19
- 10 - Signal Audio - RIO Channel 3 or 19
- 11 - Signal Audio + RIO Channel 4 or 20
- 12 - Signal Audio - RIO Channel 4 or 20
- 13 - Common
- 14 - Common
- 15 - Signal Audio + RIO Channel 5 or 21
- 16 - Signal Audio - RIO Channel 5 or 21
- 17 - Signal Audio + RIO Channel 6 or 22
- 18 - Signal Audio - RIO Channel 6 or 22
- 19 - Common
- 20 - Common
- 21 - Signal Audio + RIO Channel 7 or 23
- 22 - Signal Audio - RIO Channel 7 or 23
- 23 - Signal Audio + RIO Channel 8 or 24
- 24 - Signal Audio - RIO Channel 8 or 24
- 25 - Common
- 26 - Common
- 27 - Signal Audio + RIO Channel 9 or 25
- 28 - Signal Audio - RIO Channel 9 or 25
- 29 - Signal Audio + RIO Channel 10 or 26
- 30 - Signal Audio - RIO Channel 10 or 26
- 31 - Common
- 32 - Common
- 33 - Signal Audio + RIO Channel 11 or 27
- 34 - Signal Audio - RIO Channel 11 or 27
- 35 - Signal Audio + RIO Channel 12 or 28
- 36 - Signal Audio - RIO Channel 12 or 28
- 37 - Common
- 38 - Common
- 39 - Signal Audio + RIO Channel 13 or 29
- 40 - Signal Audio - RIO Channel 13 or 29
- 41 - Signal Audio + RIO Channel 14 or 30
- 42 - Signal Audio - RIO Channel 14 or 30
- 43 - Common
- 44 - Common
- 45 - Signal Audio + RIO Channel 15 or 31
- 46 - Signal Audio - RIO Channel 15 or 31
- 47 - Signal Audio + RIO Channel 16 or 32
- 48 - Signal Audio - RIO Channel 16 or 32
- 49 - Common
- 50 - Common

↖ For Connector 1-16
 ↗ For Connector 17-32

RIO Chassis Digital (AES) Signal Connector Terminal/Pin Assignment (Input and Output)

The RIO Chassis connector for AES digital I/O is designed to connect directly to a standard 50 pin terminal block such as the 66 or Krone that has an RJ21 connector option. Utilizing off the shelf telephone CAT V, and telephone block, the terminal block pin detail is as follows.

Standard Punch Block with
50 Pin RJ21 on the Side.

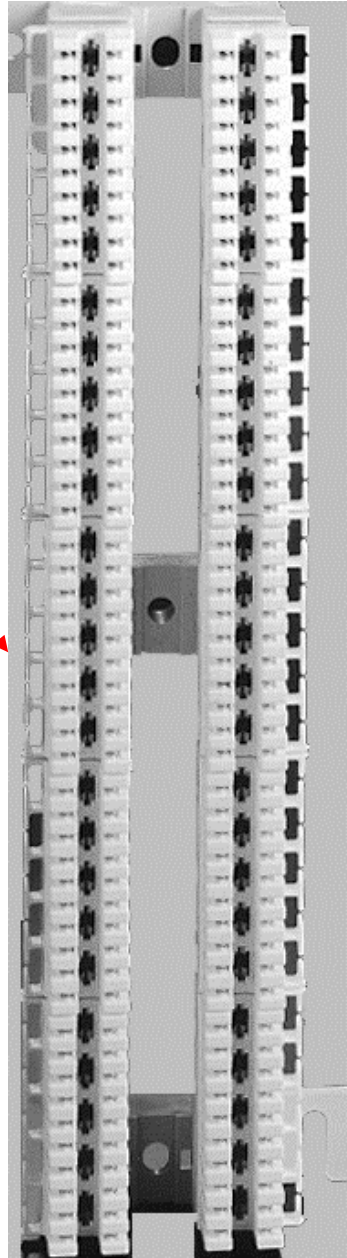

- 1 - Common
- 2 - Common
- 3 - Signal AES + RIO Channel 1 and 2 or 17 and 18
- 4 - Signal AES - RIO Channel 1 and 2 or 17 and 18
- 5 - Signal AES + RIO Channel 3 and 4 or 19 and 20
- 6 - Signal AES - RIO Channel 3 and 4 or 19 and 20
- 7 - Common
- 8 - Common
- 9 - Signal AES + RIO Channel 5 and 6 or 21 and 22
- 10 - Signal AES - RIO Channel 5 and 6 or 21 and 22
- 11 - Signal AES + RIO Channel 7 and 8 or 23 and 24
- 12 - Signal AES - RIO Channel 7 and 8 or 23 and 24
- 13 - Common
- 14 - Common
- 15 - Signal AES + RIO Channel 9 and 10 or 25 and 26
- 16 - Signal AES - RIO Channel 9 and 10 or 25 and 26
- 17 - Signal AES + RIO Channel 11 and 12 or 27 and 28
- 18 - Signal AES - RIO Channel 11 and 12 or 27 and 28
- 19 - Common
- 20 - Common
- 21 - Signal AES + RIO Channel 13 and 14 or 29 and 30
- 22 - Signal AES - RIO Channel 13 and 14 or 29 and 30
- 23 - Signal AES + RIO Channel 15 and 16 or 31 and 32
- 24 - Signal AES - RIO Channel 15 and 16 or 31 and 32
- 25 - Common
- 26 - Common
- 27 -
- 28 -
- 29 -
- 30 -
- 31 -
- 32 -
- 33 -
- 34 -
- 35 -
- 36 -
- 37 -
- 38 -
- 39 -
- 40 -
- 41 -
- 42 -
- 43 -
- 44 -
- 45 -
- 46 -
- 47 -
- 48 -
- 49 -
- 50 -

↖ For Connector 1-16
 ↖ For Connector 17-32

RIO Chassis RS485 Control Port Connector Terminal/Pin Assignment

The RIO Chassis connector for RS485 control ports is designed to connect directly to a standard 50 pin terminal block such as the 66 or Krone that has an RJ21 connector option. Utilizing off the shelf telephone CAT V, and telephone block, the terminal block pin detail is as follows.

Standard Punch Block with
50 Pin RJ21 on the Side.

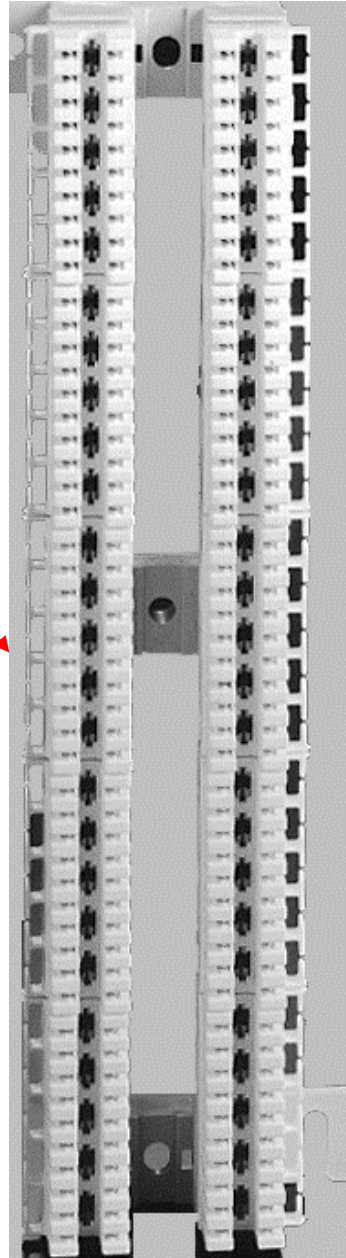

- 1 - Common
- 2 - Common
- 3 - RS485 Port + 1
- 4 - RS485 Port - 1
- 5 - RS485 Port + 2
- 6 - RS485 Port - 2
- 7 - Common
- 8 - Common
- 9 - RS485 Port + 3
- 10 - RS485 Port - 3
- 11 - RS485 Port + 4
- 12 - RS485 Port - 4
- 13 - Common
- 14 - Common
- 15 - RS485 Port + 5
- 16 - RS485 Port - 5
- 17 - RS485 Port + 6
- 18 - RS485 Port - 6
- 19 - Common
- 20 - Common
- 21 - RS485 Port + 7
- 22 - RS485 Port - 7
- 23 - RS485 Port + 8
- 24 - RS485 Port - 8
- 25 - Common
- 26 - Common
- 27 - RS485 Port + 9
- 28 - RS485 Port - 9
- 29 - RS485 Port + 10
- 30 - RS485 Port - 10
- 31 - Common
- 32 - Common
- 33 - RS485 Port + 11
- 34 - RS485 Port - 11
- 35 - RS485 Port + 12
- 36 - RS485 Port - 12
- 37 - Common
- 38 - Common
- 39 - RS485 Port + 13
- 40 - RS485 Port - 13
- 41 - RS485 Port + 14
- 42 - RS485 Port - 14
- 43 - Common
- 44 - Common
- 45 - RS485 Port + 15
- 46 - RS485 Port - 15
- 47 - RS485 Port + 16
- 48 - RS485 Port - 16
- 49 - Common
- 50 - Common

RIO Chassis Relay Connector Terminal/Pin Assignment

The RIO Chassis connector relays are designed to connect directly to a standard 50 pin terminal block such as the 66 or Krone that has an RJ21 connector option. The relays are solid state and use a mutual conductance type of topology. The relays have a plus and minus polarity and although the relay uses the mutual conductance of a FET it is still recommended to connect the relay output with the correct polarity. Utilizing off the shelf telephone CAT V, and telephone block, the terminal block pin detail is as follows.

Standard Punch Block with
50 Pin RJ21 on the Side.

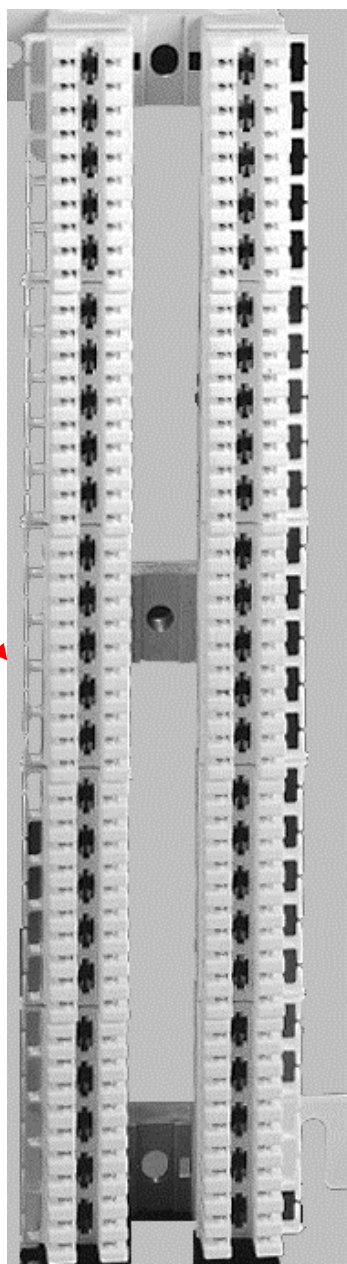

- 1 - Common
- 2 - Common
- 3 - Relay 1 + (or normally open)
- 4 - Relay 1 com
- 5 - Relay 2 + (or normally open)
- 6 - Relay 2 com
- 7 - Common
- 8 - Common
- 9 - Relay 3 + (or normally open)
- 10 - Relay 3 com
- 11 - Relay 4 + (or normally open)
- 12 - Relay 4 com
- 13 - Common
- 14 - Common
- 15 - Relay 5 + (or normally open)
- 16 - Relay 5 com
- 17 - Relay 6 + (or normally open)
- 18 - Relay 6 com
- 19 - Common
- 20 - Common
- 21 - Relay 7 + (or normally open)
- 22 - Relay 7 com
- 23 - Relay 8 + (or normally open)
- 24 - Relay 8 com
- 25 - Common
- 26 - Common
- 27 - Relay 9 + (or normally open)
- 28 - Relay 9 com
- 29 - Relay 10 + (or normally open)
- 30 - Relay 10 com
- 31 - Common
- 32 - Common
- 33 - Relay 11 + (or normally open)
- 34 - Relay 11 com
- 35 - Relay 12 + (or normally open)
- 36 - Relay 12 com
- 37 - Common
- 38 - Common
- 39 - Relay 13 + (or normally open)
- 40 - Relay 13 com
- 41 - Relay 14 + (or normally open)
- 42 - Relay 14 com
- 43 - Common
- 44 - Common
- 45 - Relay 15 + (or normally open)
- 46 - Relay 15 com
- 47 - Relay 16 + (or normally open)
- 48 - Relay 16 com
- 49 - Common
- 50 - Common

RIO Chassis Opto Isolated Inputs Connector Terminal/Pin Assignment

The RIO Chassis connector Optically Isolated Inputs are designed to connect directly to a standard 50 pin terminal block such as the 66 or Krone that has an RJ21 connector option. The optical isolators are internally current limiting and can be connected directly to a DC control line from 5 to 15 volts. The LED's on the Optical section draws between 1 mA at 5 volts to 6 mA at 15 volts. The connector also provides an internal fused 5 volts that can be used as a B+ common for connection and control from a dry contact switch. It is always recommended to feed the Common (or negative) through the dry contact to the Gnd. Utilizing off the shelf telephone CAT V, and telephone block, the terminal block pin detail is as follows.

Standard Punch Block with
50 Pin RJ21 on the Side.

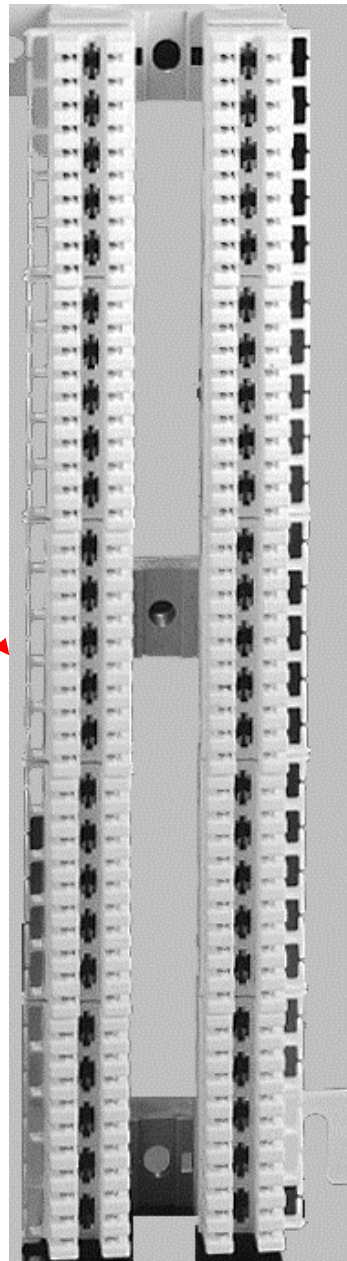

- 1 - + 5 Volts
- 2 - GND
- 3 - Opto (LED) 1 +
- 4 - Opto (LED) 1 - (Gnd)
- 5 - Opto (LED) 2 +
- 6 - Opto (LED) 2 - (Gnd)
- 7 - + 5 Volts
- 8 - GND
- 9 - Opto (LED) 3 +
- 10 - Opto (LED) 3 - (Gnd)
- 11 - Opto (LED) 4 +
- 12 - Opto (LED) 4 - (Gnd)
- 13 - + 5 Volts
- 14 - GND
- 15 - Opto (LED) 5 +
- 16 - Opto (LED) 5 - (Gnd)
- 17 - Opto (LED) 6 +
- 18 - Opto (LED) 6 - (Gnd)
- 19 - + 5 Volts
- 20 - GND
- 21 - Opto (LED) 7 +
- 22 - Opto (LED) 7 - (Gnd)
- 23 - Opto (LED) 8 +
- 24 - Opto (LED) 8 - (Gnd)
- 25 - + 5 Volts
- 26 - GND
- 27 - Opto (LED) 9 +
- 28 - Opto (LED) 9 - (Gnd)
- 29 - Opto (LED) 10 +
- 30 - Opto (LED) 10 - (Gnd)
- 31 - + 5 Volts
- 32 - GND
- 33 - Opto (LED) 11 +
- 34 - Opto (LED) 11 - (Gnd)
- 35 - Opto (LED) 12 +
- 36 - Opto (LED) 12 - (Gnd)
- 37 - + 5 Volts
- 38 - GND
- 39 - Opto (LED) 13 +
- 40 - Opto (LED) 13 - (Gnd)
- 41 - Opto (LED) 14 +
- 42 - Opto (LED) 14 - (Gnd)
- 43 - + 5 Volts
- 44 - GND
- 45 - Opto (LED) 15 +
- 46 - Opto (LED) 15 - (Gnd)
- 47 - Opto (LED) 16 +
- 48 - Opto (LED) 16 - (Gnd)
- 49 - + 5 Volts
- 50 - GND



EURO Connector Pin Detail for Analog I/O
(For KAI-16 and KAO-16 Analog Modules)

Rear View
 (Rear of Frame)

C		B		A	
1	Sig 1 +	1	Sig 1 -	1	Sig 1 Gnd
2	Sig 2 +	2	Sig 2 -	2	Sig 2 Gnd
3	Sig 3 +	3	Sig 3 -	3	Sig 3 Gnd
4	Sig 4 +	4	Sig 4 -	4	Sig 4 Gnd
5	Sig 5 +	5	Sig 5 -	5	Sig 5 Gnd
6	Sig 6 +	6	Sig 6 -	6	Sig 6 Gnd
7	Sig 7 +	7	Sig 7 -	7	Sig 7 Gnd
8	Sig 8 +	8	Sig 8 -	8	Sig 8 Gnd
9	Sig 9 +	9	Sig 9 -	9	Sig 9 Gnd
10	Sig 10 +	10	Sig 10 -	10	Sig 10 Gnd
11	Sig 11 +	11	Sig 11 -	11	Sig 11 Gnd
12	Sig 12 +	12	Sig 12 -	12	Sig 12 Gnd
13	Sig 13 +	13	Sig 13 -	13	Sig 13 Gnd
14	Sig 14 +	14	Sig 14 -	14	Sig 14 Gnd
15	Sig 15 +	15	Sig 15 -	15	Sig 15 Gnd
16	Sig 16 +	16	Sig 16 -	16	Sig 16 Gnd
17	Sig 17 +	17	Sig 17 -	17	Sig 17 Gnd
18	Sig 18 +	18	Sig 18 -	18	Sig 18 Gnd
19	Sig 19 +	19	Sig 19 -	19	Sig 19 Gnd
20	Sig 20 +	20	Sig 20 -	20	Sig 20 Gnd
21	Sig 21 +	21	Sig 21 -	21	Sig 21 Gnd
22	Sig 22 +	22	Sig 22 -	22	Sig 22 Gnd
23	Sig 23 +	23	Sig 23 -	23	Sig 23 Gnd
24	Sig 24 +	24	Sig 1 -	24	Sig 24 Gnd
25	Sig 25 +	25	Sig 25 -	25	Sig 25 Gnd
26	Sig 26 +	26	Sig 26 -	26	Sig 26 Gnd
27	Sig 27 +	27	Sig 27 -	27	Sig 27 Gnd
28	Sig 28 +	28	Sig 28 -	28	Sig 28 Gnd
29	Sig 29 +	29	Sig 29 -	29	Sig 29 Gnd
30	Sig 30 +	30	Sig 30 -	30	Sig 30 Gnd
31	Sig 31 +	31	Sig 31 -	32	Sig 31 Gnd
32	Sig 32 +	32	Sig 32 -	32	Sig 32 Gnd



EURO Connector Pin Detail for Digital I/O
(For KDI-16 and KDO-16 Digital Modules)

Rear View (Rear of Frame)		C	B	A	
1	Sig 1 +	1	Sig 1 -	1	Sig 1 Gnd
2	Sig 2 +	2	Sig 2 -	2	Sig 2 Gnd
3	Sig 3 +	3	Sig 3 -	3	Sig 3 Gnd
4	Sig 4 +	4	Sig 4 -	4	Sig 4 Gnd
5	Sig 5 +	5	Sig 5 -	5	Sig 5 Gnd
6	Sig 6 +	6	Sig 6 -	6	Sig 6 Gnd
7	Sig 7 +	7	Sig 7 -	7	Sig 7 Gnd
8	Sig 8 +	8	Sig 8 -	8	Sig 8 Gnd
9	Sig 9 +	9	Sig 9 -	9	Sig 9 Gnd
10	Sig 10 +	10	Sig 10 -	10	Sig 10 Gnd
11	Sig 11 +	11	Sig 11 -	11	Sig 11 Gnd
12	Sig 12 +	12	Sig 12 -	12	Sig 12 Gnd
13	Sig 13 +	13	Sig 13 -	13	Sig 13 Gnd
14	Sig 14 +	14	Sig 14 -	14	Sig 14 Gnd
15	Sig 15 +	15	Sig 15 -	15	Sig 15 Gnd
16	Sig 16 +	16	Sig 16 -	16	Sig 16 Gnd
17	nc	17	nc	17	nc
18	nc	18	nc	18	nc
19	nc	19	nc	19	nc
20	nc	20	nc	20	nc
21	nc	21	nc	21	nc
22	nc	22	nc	22	nc
23	nc	23	nc	23	nc
24	nc	24	nc	24	nc
25	nc	25	nc	25	nc
26	nc	26	nc	26	nc
27	nc	27	nc	27	nc
28	nc	28	nc	28	nc
29	nc	29	nc	29	nc
30	nc	30	nc	30	nc
31	nc	31	nc	32	nc
32	nc	32	nc	32	nc



EURO Connector Pin Detail for RS-485 Ports
(For DRC-16 RS-485 Controller Module)

Rear View (Rear of Frame)		C	B	A	
1	Ctl 1 +	1	Ctl 1 -	1	Ctl 1 Gnd
2	Ctl 2 +	2	Ctl 2 -	2	Ctl 2 Gnd
3	Ctl 3 +	3	Ctl 3 -	3	Ctl 3 Gnd
4	Ctl 4 +	4	Ctl 4 -	4	Ctl 4 Gnd
5	Ctl 5 +	5	Ctl 5 -	5	Ctl 5 Gnd
6	Ctl 6 +	6	Ctl 6 -	6	Ctl 6 Gnd
7	Ctl 7 +	7	Ctl 7 -	7	Ctl 7 Gnd
8	Ctl 8 +	8	Ctl 8 -	8	Ctl 8 Gnd
9	Ctl 9 +	9	Ctl 9 -	9	Ctl 9 Gnd
10	Ctl 10 +	10	Ctl 10 -	10	Ctl 10 Gnd
11	Ctl 11 +	11	Ctl 11 -	11	Ctl 11 Gnd
12	Ctl 12 +	12	Ctl 12 -	12	Ctl 12 Gnd
13	Ctl 13 +	13	Ctl 13 -	13	Ctl 13 Gnd
14	Ctl 14 +	14	Ctl 14 -	14	Ctl 14 Gnd
15	Ctl 15 +	15	Ctl 15 -	15	Ctl 15 Gnd
16	Ctl 16 +	16	Ctl 16 -	16	Ctl 16 Gnd
17	USI 1 Tx	17	USI 1 Rx	17	USI 1 Gnd
18	USI 2 Tx	18	USI 2 Rx	18	USI 2 Gnd
19	USI 3 Tx	19	USI 3 Rx	19	USI 3 Gnd
20	USI 4 Tx	20	USI 4 Rx	20	USI 4 Gnd
21	USI 5 Tx	21	USI 5 Rx	21	USI 5 Gnd
22	n/c	22	n/c	22	n/c
23	Enet Tx +	23	Enet Tx-	23	Enet Gnd
24	Enet Rx +	24	Enet Rx-	24	Enet Gnd
25	n/c	25	n/c	25	n/c
26	n/c	26	n/c	26	n/c
27	n/c	27	n/c	27	n/c
28	n/c	28	n/c	28	n/c
29	n/c	29	n/c	29	n/c
30	n/c	30	n/c	30	n/c
31	n/c	31	n/c	32	n/c
32	n/c	32	n/c	32	n/c

RS-485 Serial Control Ports.
To Alpha Numeric Control Panels

RS-232 Serial Control Ports.
User Serial Interface To Automation or DAD



EURO Connector Pin Detail for MCU-32E
 (For MCU-32E RS-485 and RS232 Serial Ports)

Rear View (Rear of Frame)		C	B	A	
1	RS-485+	1	RS-485-	1	Gnd – RS-485 Port 1
2	RS-485+	2	RS-485-	2	Gnd - RS-485 Port 2
3	RS-232 Tx	3	RS-232 Rx	3	Gnd - To RCS ^{win} Computer
4		4		4	<p style="text-align: center;">No User Connections</p>
5		5		5	
6		6		6	
7		7		7	
8		8		8	
9		9		9	
10		10		10	
11		11		11	
12		12		12	
13		13		13	
14		14		14	
15		15		15	
16		16		16	
17		17		17	
18		18		18	
19		19		19	
20		20		20	
21		21		21	
22		22		22	
23		23		23	
24		24		24	
25		25		25	
26		26		26	
27		27		27	
28		28		28	
29		29		29	
30		30		30	
31		31		32	
32		32		32	

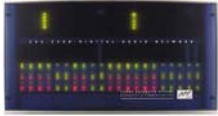

Typical Application

The SAS 32KD Switching Network system is suitable for a Radio Broadcast facility distribution system. Utilizing a variety of control options from fully automated to single output manual control, the system can provide switching/mixing and Intercom (auto IFB), and is popular for configuring audio consoles routable fader channels (remote faders) and automatically steering mix minus feeds for IFB.

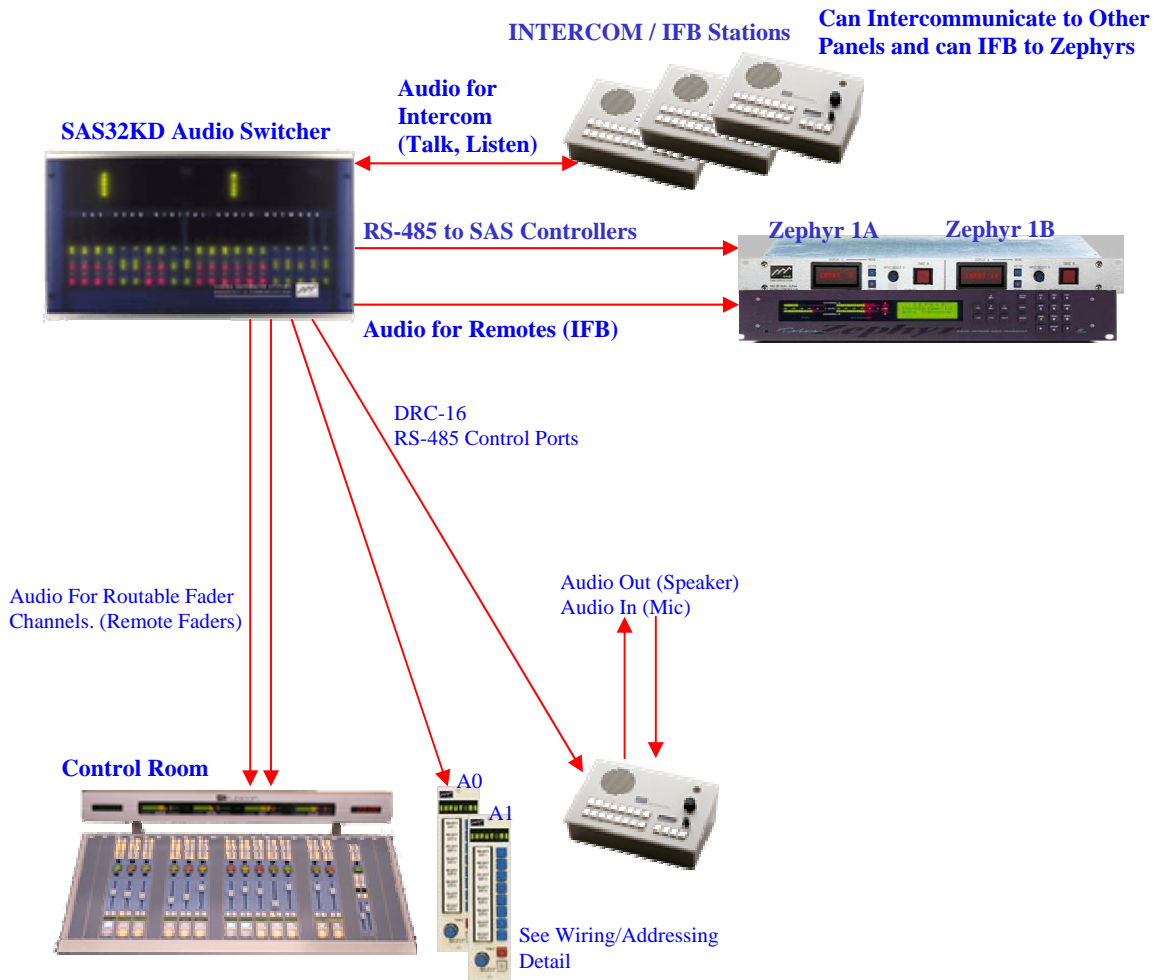



SAS 32KD Startup Wiring Guide

RCS^{Win} Software

SAS 32KD Audio Switching Network

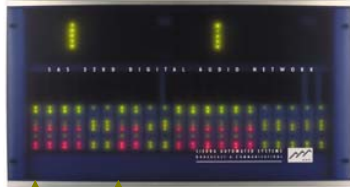

MCU-32 (C3.B3.A3)
(Slot 21) *

COM PORT
DB9 (2,3,5)
DB25(3,2,7)



DRC-16 (C1.B1.A1)
(Slot 19) *

SYS RS485
(4,5,1)

AXC-8



KRL-16
Multi-channel I/O on
CAT V (or Fiber)

* Recommended

Slot 1 Slot 8
KAI-16 or KDI-16
Audio Inputs

Slot 9 Slot 16
KAO-16 or KDO-16
Audio Outputs

CAT V

CAT V



Audio In

Audio Out

RS-485
Ports
DRC-16

Punch Blocks

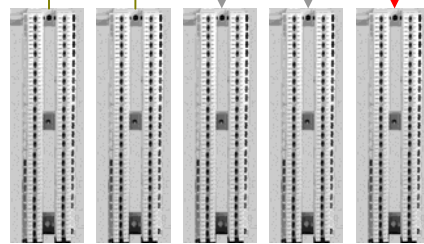

Audio Inputs Audio Outputs Control

See Punch Block Wiring for SAS Standard
and Recommended Terminal Pin Outs.



Audio to Destination (Control Room)
(Typically, Audio Pair and Control Pair to
Remote location)

SAS Standard Block Wiring Digital In/Out.

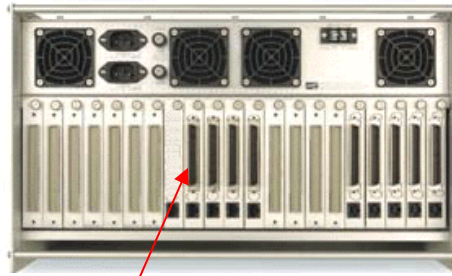

Wiring using a standard 50 pin (25 Pair) CAT V telephone cable. 50 Pin RJ21 can only be used for digital I/O. (not Analog I/O).

Note: These are Signal Channels 1-32 of the Module.

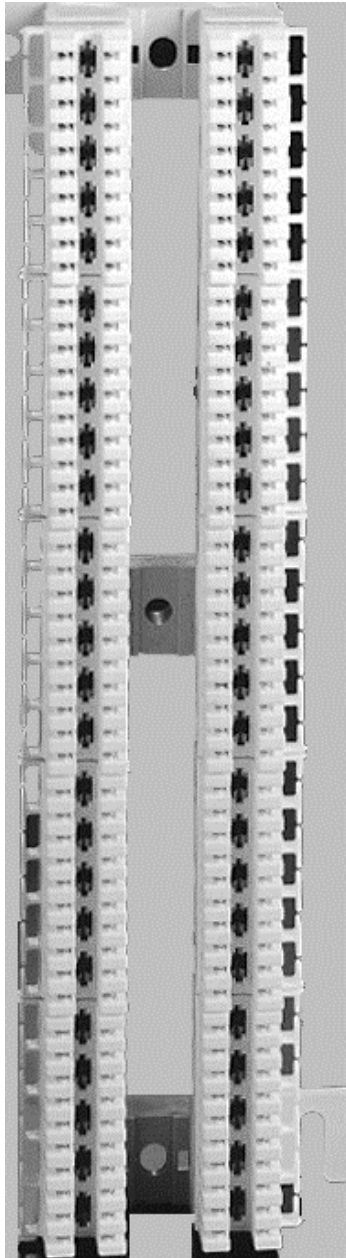

- 1 - Common
- 2 - Common
- 3 - Signal AES + Channel 1 and 2
- 4 - Signal AES - Channel 1 and 2
- 5 - Signal AES + Channel 3 and 4
- 6 - Signal AES - Channel 3 and 4
- 7 - Common
- 8 - Common
- 9 - Signal AES + Channel 5 and 6
- 10 - Signal AES - Channel 5 and 6
- 11 - Signal AES + Channel 7 and 8
- 12 - Signal AES - Channel 7 and 8
- 13 - Common
- 14 - Common
- 15 - Signal AES + Channel 9 and 10
- 16 - Signal AES - Channel 9 and 10
- 17 - Signal AES + Channel 11 and 12
- 18 - Signal AES - Channel 11 and 12
- 19 - Common
- 20 - Common
- 21 - Signal AES + Channel 13 and 14
- 22 - Signal AES - Channel 13 and 14
- 23 - Signal AES + Channel 15 and 16
- 24 - Signal AES - Channel 15 and 16
- 25 - Common
- 26 - Common
- 27 - Signal AES + Channel 17 and 18
- 28 - Signal AES - Channel 17 and 18
- 29 - Signal AES + Channel 19 and 20
- 30 - Signal AES - Channel 19 and 20
- 31 - Common
- 32 - Common
- 33 - Signal AES + Channel 21 and 22
- 34 - Signal AES - Channel 21 and 22
- 35 - Signal AES + Channel 23 and 24
- 36 - Signal AES - Channel 23 and 24
- 37 - Common
- 38 - Common
- 39 - Signal AES + Channel 25 and 26
- 40 - Signal AES - Channel 25 and 26
- 41 - Signal AES + Channel 27 and 28
- 42 - Signal AES - Channel 27 and 28
- 43 - Common
- 44 - Common
- 45 - Signal AES + Channel 29 and 30
- 46 - Signal AES - Channel 29 and 30
- 47 - Signal AES + Channel 31 and 32
- 48 - Signal AES - Channel 31 and 32
- 49 - Common
- 50 - Common

SAS Standard Block Wiring Analog In/Out.

Analog I/O uses EURO connector module only. All 32 audio signal pairs are brought out to punch blocks as follows. SAS supplied/standard and Recommends wiring to blocks as follows. Each Euro Connector Module breaks out to 2 blocks housing 16 signal pairs each.

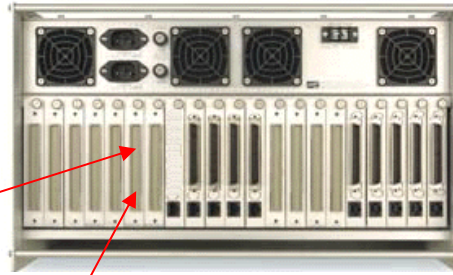

Note: These are Signal Channels 1-32 of the Module

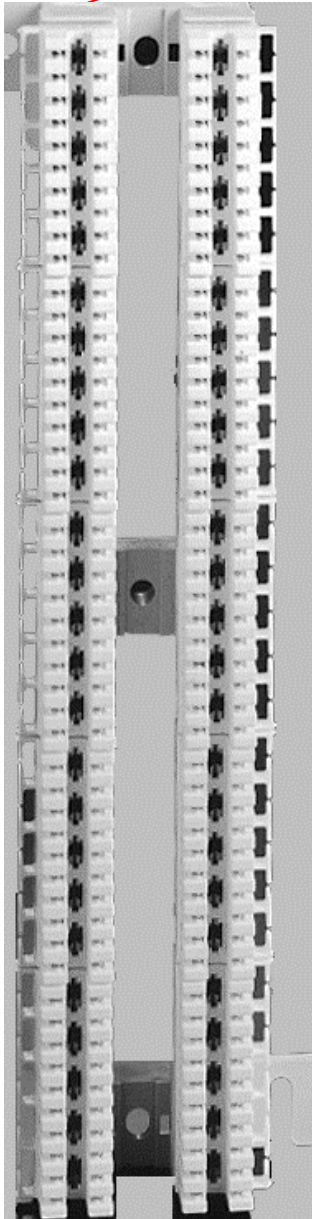

- 1 - Common
- 2 - Common
- 3 - Signal Audio + 1
- 4 - Signal Audio - 1
- 5 - Signal Audio + 2
- 6 - Signal Audio - 2
- 7 - Common
- 8 - Common
- 9 - Signal Audio + 3
- 10 - Signal Audio - 3
- 11 - Signal Audio + 4
- 12 - Signal Audio - 4
- 13 - Common
- 14 - Common
- 15 - Signal Audio + 5
- 16 - Signal Audio - 5
- 17 - Signal Audio + 6
- 18 - Signal Audio - 6
- 19 - Common
- 20 - Common
- 21 - Signal Audio + 7
- 22 - Signal Audio - 7
- 23 - Signal Audio + 8
- 24 - Signal Audio - 8
- 25 - Common
- 26 - Common
- 27 - Signal Audio + 9
- 28 - Signal Audio - 9
- 29 - Signal Audio + 10
- 30 - Signal Audio - 10
- 31 - Common
- 32 - Common
- 33 - Signal Audio + 11
- 34 - Signal Audio - 11
- 35 - Signal Audio + 12
- 36 - Signal Audio - 12
- 37 - Common
- 38 - Common
- 39 - Signal Audio + 13
- 40 - Signal Audio - 13
- 41 - Signal Audio + 14
- 42 - Signal Audio - 14
- 43 - Common
- 44 - Common
- 45 - Signal Audio + 15
- 46 - Signal Audio - 15
- 47 - Signal Audio + 16
- 48 - Signal Audio - 16
- 49 - Common
- 50 - Common

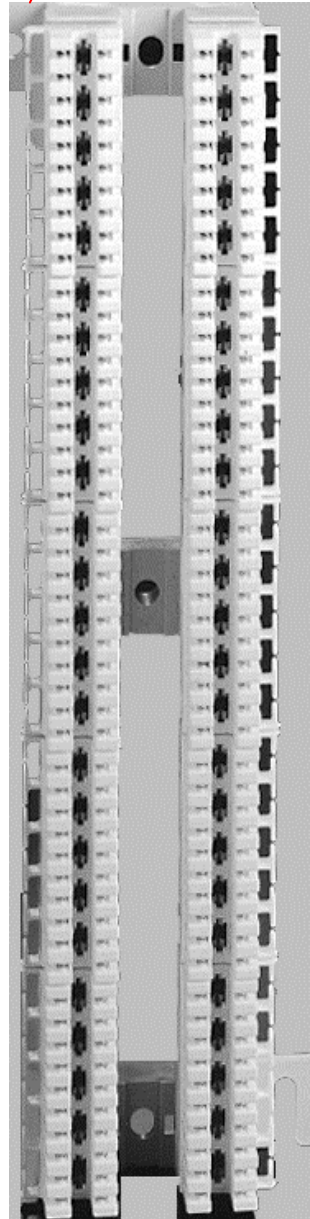

- 1 - Common
- 2 - Common
- 3 - Signal Audio + 17
- 4 - Signal Audio - 17
- 5 - Signal Audio + 18
- 6 - Signal Audio - 18
- 7 - Common
- 8 - Common
- 9 - Signal Audio + 19
- 10 - Signal Audio - 19
- 11 - Signal Audio + 20
- 12 - Signal Audio - 20
- 13 - Common
- 14 - Common
- 15 - Signal Audio + 21
- 16 - Signal Audio - 21
- 17 - Signal Audio + 22
- 18 - Signal Audio - 22
- 19 - Common
- 20 - Common
- 21 - Signal Audio + 23
- 22 - Signal Audio - 23
- 23 - Signal Audio + 24
- 24 - Signal Audio - 24
- 25 - Common
- 26 - Common
- 27 - Signal Audio + 25
- 28 - Signal Audio - 25
- 29 - Signal Audio + 26
- 30 - Signal Audio - 26
- 31 - Common
- 32 - Common
- 33 - Signal Audio + 27
- 34 - Signal Audio - 27
- 35 - Signal Audio + 28
- 36 - Signal Audio - 28
- 37 - Common
- 38 - Common
- 39 - Signal Audio + 29
- 40 - Signal Audio - 29
- 41 - Signal Audio + 30
- 42 - Signal Audio - 30
- 43 - Common
- 44 - Common
- 45 - Signal Audio + 31
- 46 - Signal Audio - 31
- 47 - Signal Audio + 32
- 48 - Signal Audio - 32
- 49 - Common
- 50 - Common



External AES/Clock Input

The SAS 32KD switching network system provides a clock system internally. The internal clock rate is selectable using the RCS windows software from the Switcher Status/Configuration main window. As shown the internal default clock options are 32K, 44.1K, and 48K

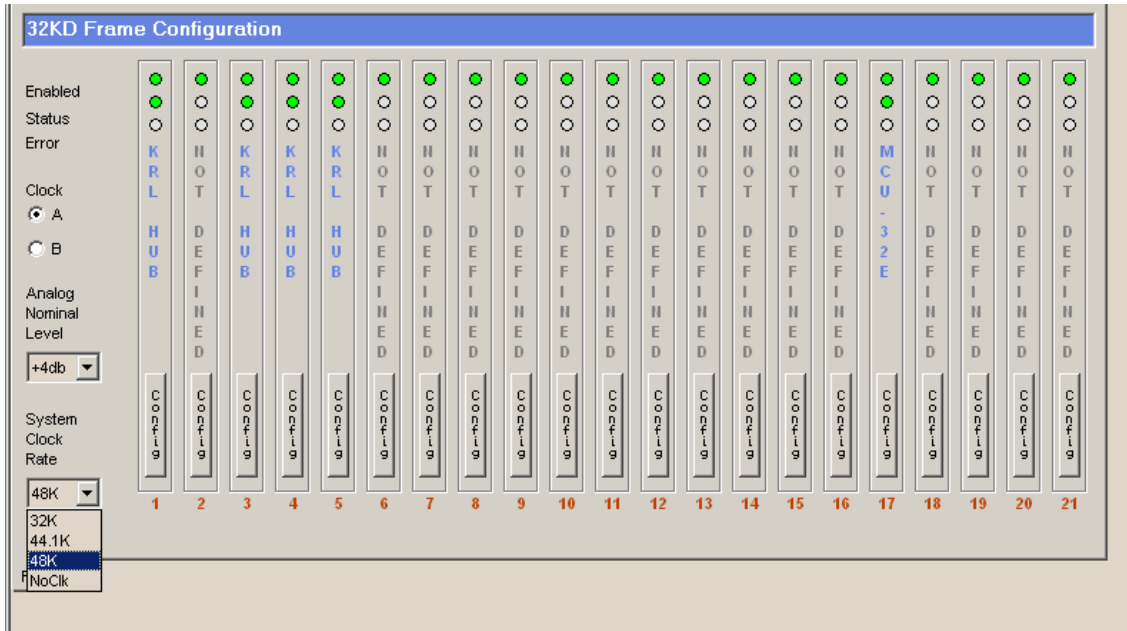

The main frame additionally provides an external AES3/AES11 input for external clock reference. Connecting an external clock to this input causes all outputs within the frame to be clock/frame synchronous to the external reference clock. The software selectable system clock rate is ignored when a valid external clock is detected. The rear of the frame provides a male 9 Pin D sub connector (DB9P) for external AES clock entry. The clock signal can be an AES3 or AES11 (clock sync signal) which is a balanced differential signal requiring 3 pin connections as follows:

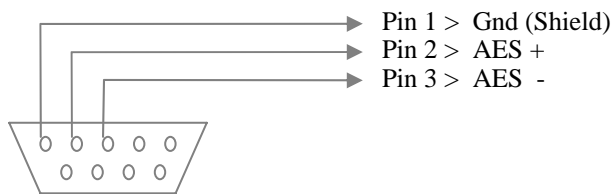

DB9P (Female Cable End)
Rear Cable end View



Stereo and Mono Mode Programming.

The SAS 32KD switching system provides a simple control environment to manage stereo and mono signal channels. The RCS (Router Control Software) allows adjacent channels to be linked together to create a stereo pair for both Input and Output signals. If not linked, then the adjacent channels are treated as Mono signals. The Stereo “link” is accomplished on the Alpha Programming window where the Input and Output names are assigned. The Inputs can be optionally configured for Mono or Stereo. The Outputs can be optionally linked as Mono, Stereo, Mono L+R, or Source Dependent.

INPUT Channel Alpha and Link Programming Window.

Alpha Labels Programming Window.

Chan #	Chan Label	Linked	Hidden	Notes
1	INPT0001	Stereo	No	Notes for Channel C
2	INPT0002	Mono	No	Notes for Channel C
3	INPT0003	Stereo	No	Notes for Channel C
4	INPT0004	Mono	No	Notes for Channel C
5	INPT0005	Mono	No	Notes for Channel C
6	INPT0006	Mono	No	Notes for Channel C
7	INPT0007	Mono	No	Notes for Channel C

1. Select from Pull Down Stereo or Mono Mode for Inputs 1 and 2.

2. Input 1 is treated as LEFT Ch. Input 2 is treated as RIGHT Ch. Use the HIDE function on the RIGHT Channel (Input 2) to remove from Alpha numeric controllers Directory.

OUTPUT Channel Alpha and Link Programming Window.

Alpha Labels Programming Window.

Chan #	Chan Label	Linked	Hidden	Notes
1	OUT 0001	Mono	No	Notes for Channel 0001
2	OUT 0002	Mono	No	Notes for Channel 0002
3	OUT 0003	Stereo	No	Notes for Channel 0003
4	OUT 0004	Source Dependant	No	Notes for Channel 0004
5	OUT 0005	Mono - LR Sum	No	Notes for Channel 0005
6	OUT 0006	Mono	No	Notes for Channel 0006
7	OUT 0007	Mono	No	Notes for Channel 0007
8	OUT 0008	Mono	No	Notes for Channel 0008
9	OUT 0009	Mono	No	Notes for Channel 0009
10	OUT 0010	Mono	No	Notes for Channel 0010
11	OUT 0011	Mono	No	Notes for Channel 0011

1. Select from Pull Down
 - a. Mono - treats Output as single channel Mono.
 - b. Stereo - treats Outputs 1 and 2 as Stereo pair.
 - c. Source Dependant - If a mono source is selected then only Ch.1 changes. If Stereo Source is selected, Ch.1 and Ch.2 (left and Right) changes.
 - d. Mono LR Sum- Ch.1 is treated as Mono Output. If a Stereo source is selected, then Ch.1 is L+R divided by 2 (no 6 db rise in level).



Stereo and Mono Mode Programming.

Typically when the adjacent channels are linked as stereo pairs, the HIDE function is used to remove the Right channel (source or destination) alpha label from the directory used by the alpha numeric controllers. (Since the Right channel will always try to follow the Left channel as a stereo pair). Adjacent channels starting with the ODD number only are allowed to be linked as stereo pairs. For example, Output channels 1 and 2 can be linked as Stereo, NOT output Channels 2 and 3. If the actual signal output module is an AES digital output module then the channel pair starting with the ODD channel number are grouped as the A and B segments respectively. See notes below.

Typical Configuration Example for Destination Channels.

Chan	Chan Label	Linked	Hidden	Channel No
1	UPLink1	Stereo	No	Terminal Block 1, pins 1,2,3, cross connect wire 1050
2	OUT 0002	Stereo	Yes	Terminal Block 1, pins 4,5,6, cross connect wire 1051
3	MusOnHld	Mono	No	Terminal Block 1, pins 7,8,9, cross connect wire 1052
4	OUT 0004	Mono	No	Terminal Block 1, pins 10,11,12, cross connect wire 10
5	Zephyr1A	Mono	No	Mix Minus with IFB To Remote Zephyr
6	Zephyr1B	Mono - LR Sum	No	Sums Left and Right typical for PA Feed
7	Cit1Rmt1	Source Dependant	No	
8	Cit1Rmt1	Source Dependant	Yes	
9	Zephyr2A	Mono	No	Notes for Channel 0009
10	Zephyr2B	Mono - LR Sum	No	Notes for Channel 0010
11	OUT 0011	Mono	No	Notes for Channel 0011
12	OUT 0012	Mono	No	Notes for Channel 0012

Handwritten annotations on the right side of the screenshot:

- Blue bracket labeled 'A' and 'B' spans rows 1 and 2, with text 'AES Digital OUT (Boundary)'.
- Blue bracket labeled 'A' and 'B' spans rows 5 and 6, with text 'AES Digital OUT'.
- Blue text 'Mix Minus/IFB PA Feed' is written near row 5.

Typical Configuration Example for Source Channels.

Chan	Chan Label	Linked	Hidden	Cha
1	Cit1Pgm1	Stereo	No	Notes for Channel 0001
2	INPT0002	Stereo	Yes	Notes for Channel 0002
3	Cit2Pgm2	Stereo	No	Notes for Channel 0003
4	INPT0004	Stereo	Yes	Notes for Channel 0004
5	Cit1 MM1	Mono	No	Notes for Channel 0005
6	Cit1 MM2	Mono	No	Notes for Channel 0006
7	Cit2 MM1	Mono	No	Notes for Channel 0007
8	Cit2 MM2	Mono	No	Notes for Channel 0008
9	INPT0009	Mono	No	Notes for Channel 0009
10	INPT0010	Mono	No	Notes for Channel 0010
11	INPT0011	Mono	No	Notes for Channel 0011

Handwritten annotations on the right side of the screenshot:

- Blue bracket labeled 'A' and 'B' spans rows 1 and 2, with text 'AES Digital IN (Boundary)'.

Typical Crosspoint Map Display.

The following window is a view of what the Crosspoint map display would look like when the alpha names and links are programmed as in the above example. (Source and Destination). This example is used to illustrate the stereo and mono mode differences. Inputs 1 and 2 are linked as a stereo pair shown here with the alpha label "CtlPgm1" appearing across the linked channel numbers "001,002". (Stereo Boundary). Also, Outputs 1 and 2 are linked as a Stereo pair with it's label "UPLink1" also appearing across the linked channel numbers. A switcher mapping is indicated with a green dot and shows the input (column) that is currently selected to the output (Row). In this example, inputs 1 and 2 (Ctl Pgm1 Stereo) is feeding outputs 1 and 2 (UPLink1 Stereo). The odd channels are treated as Stereo left (or AES A), and the even channels are treated as stereo right (or AES B). Intuitively displayed, ch.1 (odd) is "Left" of Ch.2 (even). A two (2) channel codec is being fed from a pair of outputs channel 5 and channel 6 and is configured as a 2 channel (mono) split feed. The interconnect to the codec can be analog or digital. If a digital interface is used, remember that the ODD channel is the AES A side or LEFT, and the EVEN Channel is the AES B side or RIGHT, so it is recommended to adopt this convention early in the planning stages. The example shows that the Left (ch.5) or AES A side is programmed as a Mono destination that is suitable for a Mix Minus feed (Ctl2 MM1) from the Control Room console. Similarly, the Right (ch.6) or AES B side is programmed as a Mono LR Sum that suitable for a PA feed at the remote. The B channel (OUT 6) has a mono sum of Ctl2 Pgm2 as shown with the 2 (two) green dots. The Mono sum function performs a divide by 2 to maintain consistent audio levels and will not result in the 5 to 6 db rise normally associated with mono Left plus Right summing. Similarly, codec Zephyr 2 is setup to do a remote from Control room 1 where the Mix Minus from the control room is feeding mono channel A (OUT 9) while the program 1 feed is L+R summed to channel B (out 10) for the PA feed.

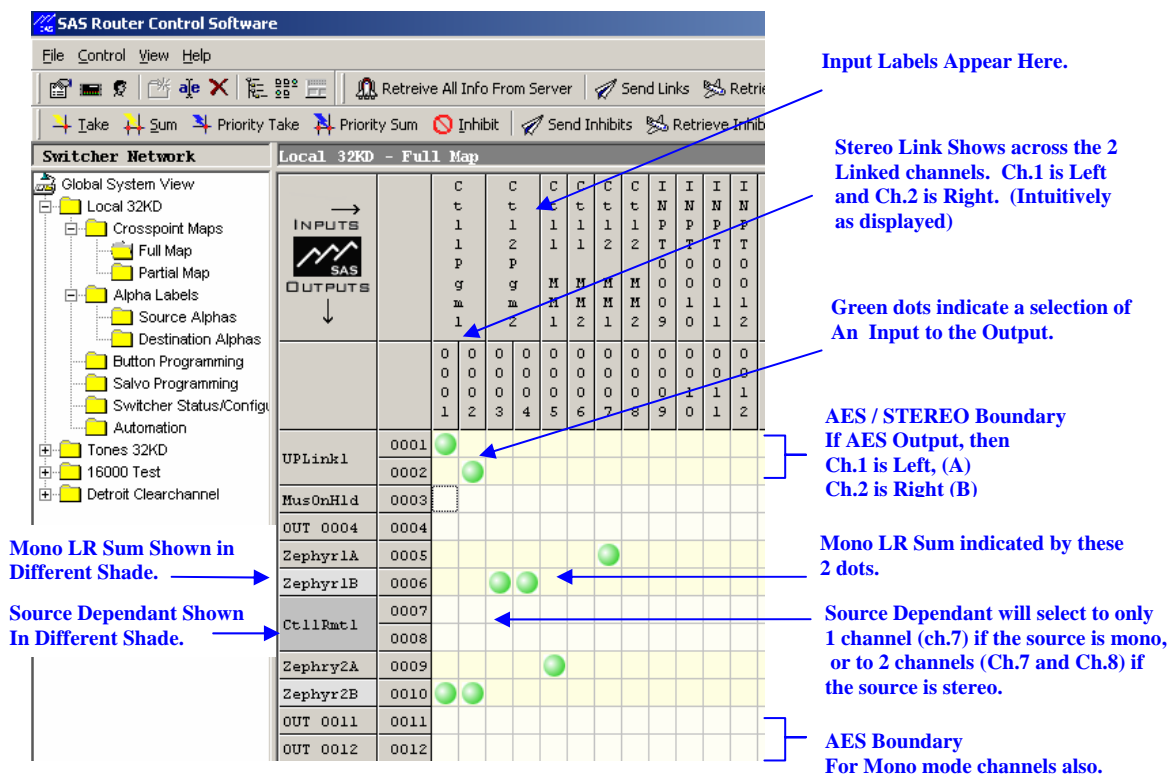



SAS Control Panel Wiring Detail

All SAS alpha numeric Control Panels communicate to the system using an RS-485 serial port and connects directly to a DCR-16 Multi port Module. Each Controller will allow source selection to a single output by using an alphabetically sorted dial up directory displayed on an 8 character alpha numeric readout. A TAKE Button is pressed to complete the switcher selection. Each RS-485 Serial control port is programmable to allow up to two (2) SAS switcher controllers using a digital “Addressing” technique. All Controllers use a 9 Pin D sub (male) connector for interconnecting the RS485 serial port (+,- Shield) to the corresponding DCR-16 Serial RS-485 Port. If using multiple panels on a serial RS-485 port, the address strap is installed on the cable end 9 Pin D-Sub (female that connects to the controller) allowing panel interchange-ability with out having to deal with “addressing DIP or Jumper” settings. The address jumper for Console “Drop In” Series is slightly different than the equivalent “Rack Mount” Series as shown below.

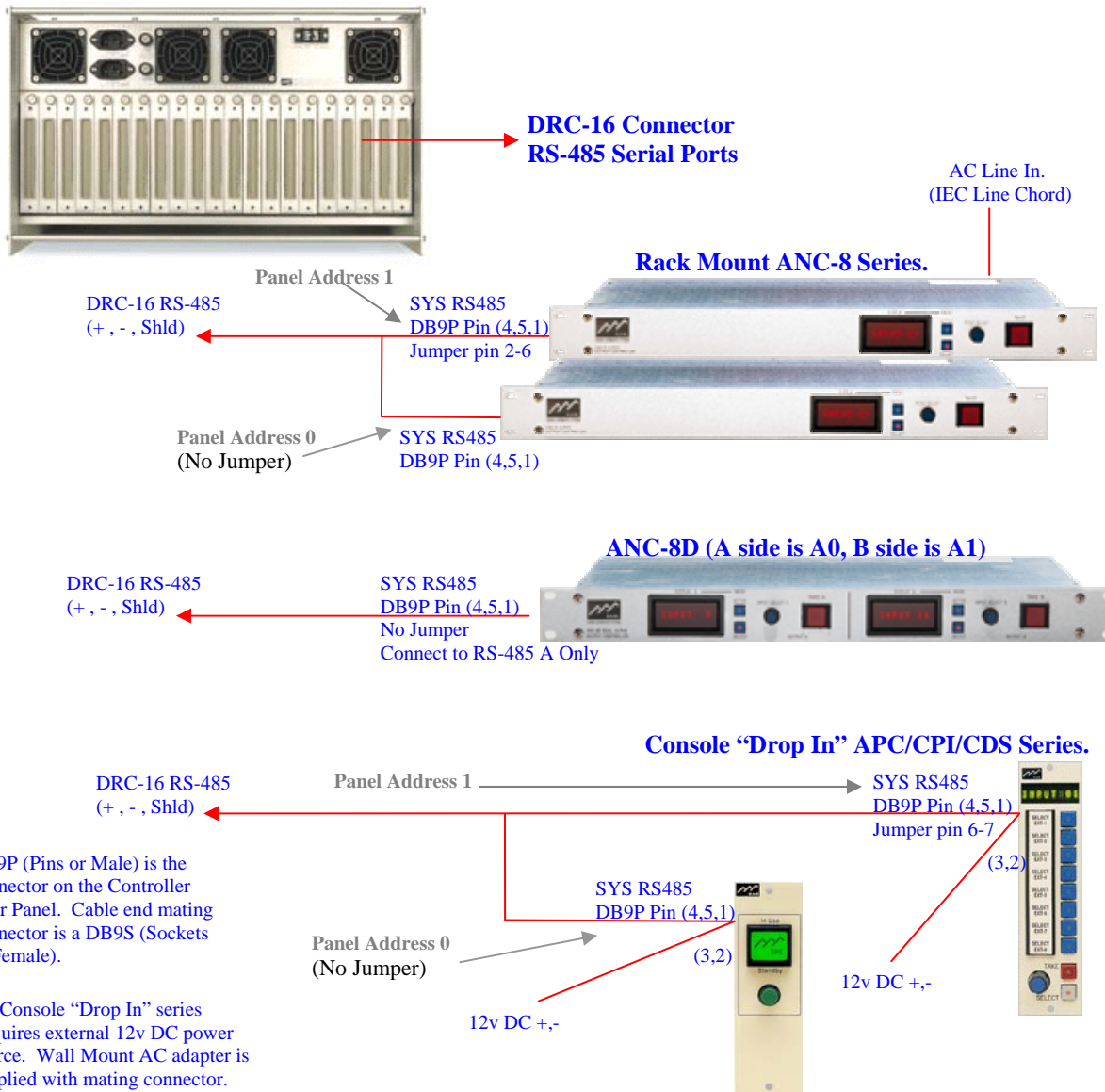



SAS Control Panel Configuration/Assignment

The RCS (Router Control Software) is used to assign the Actual Switcher Output channel that each installed Alpha Numeric controller is to direct. The frame will automatically learn the module that is installed into each of the 21 slots, and if a DRC-16 is installed, the following window is used to configure the control ports and assign the outputs for each of the controllers.

Window to Configure DRC-16 (16 RS-485 Serial Ports).

System learns DRC-16 Module is installed.

Click Here to Configure The control Ports.

**Port 1 is XY (Full System Access Port).
Port 2,3,4 are ICM (Intercom) Port
Port 5-16 are SOC (Single Output Control) Port.
Use Scroll Bar to see Ports 12-16.**

**A0 and A1 Controllers
A0=no Jumper, A1= Jumper
On 9 pin D (see above)**

Select the Output To be controlled.

**Select Control Panel Type:
Single Output
Intercom
XY
Single Input Controller**

**Port 1
Address 0
Panel at A0 (no Jumper)**

Port Type
 SOC Panel McCurdy Intercom
 XY Panel SIC Panel



SAS Control Panel Configuration Expanded Addressing (to 8)

Optionally, the DRC-16 RS-485 control port module can be configured to address up to eight (8) SAS type control panels. All rack mount type (ANC-8, ANC-8D and AXC-8) series panels only support two addresses A0 and A1. The console drop in type, and rack mount type APC-88 and CDS-8 series will support all eight (8) addresses. Additionally, the RCS-16 and DCS-16 intercom stations support all eight (8) addresses as well. The table below shows the connector pin jumpers for the expanded eight address operation. The active addresses each port can be set using the RCS^{win} routers control software configuration screen for the DRC-16 module.

Window to Configure DRC-16 (16 RS-485 Serial Ports).

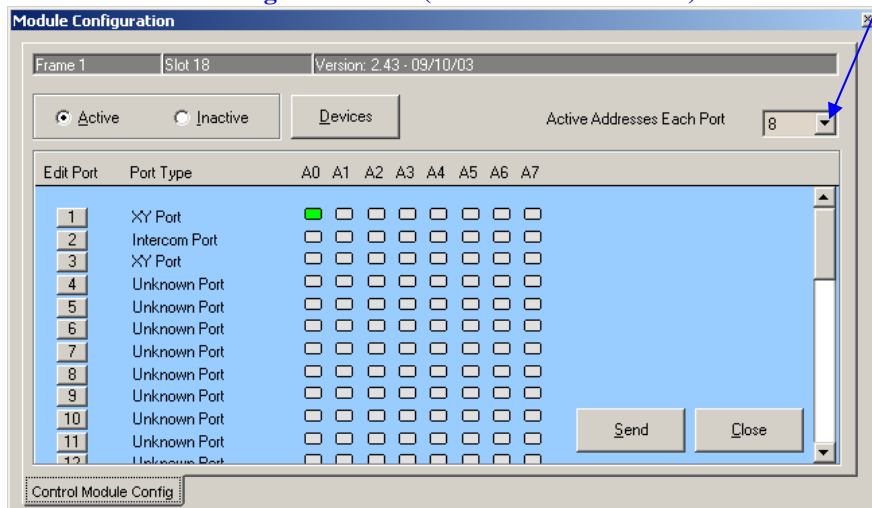

[Click here to set number of panel Addresses for each port on this module \(16\)](#)

**APC-88, CDS-8 Switcher Controllers
RCS-16/8, DCS-16/8 Intercom Controllers Address Table**

Panel Type	A0	A1	A2	A3	A4	A5	A6	A7
APC/CDS (9 pin D)	No jumper	6-7	6-8	6-7-8	6-9	6-7-9	6-8-9	6-7-8-9
RCS/DCS (25 pin D)	No jumper	16-4	17-5	16-4 17-5	18-6	16-4 18-6	17-5 18-6	16-4 17-5 18-6



GPI 1600 Opto/Relay Control Panel

The GPI 1600 opto and Relay Control panel provides 16 optically isolated DC inputs and 16 Relay isolated DC outputs that can be utilized for various ancillary functions. The GPI 1600 connects to the system on any of the DRC-16 RS-485 control ports. The RCS (router control software) is used to configure the opto inputs and relay output for functions as follows and the DRC-16 port type should be set for XY.

1. Opto Input can be mapped to a Relay output for DC control Steering.
2. Relay can be activated based on switcher selection (mapping).
3. Relay can be activated based on an automation event.

Connecting the GPI-1600.

The GPI 1600 connects to the DRC-16 RS-485 serial port as follows. Port 1 is used as an example and any of the control ports (see DRC-16 connector detail above) can be used. The RCS (router software) will recognize the device attached as a GPI-1600 and allow the opto inputs and relay outputs to be configured in the Status/Configuration window. Slave GPI1600 operation requires firmware version SAS32KD rev 1.3 or later. The version is shown in the module configuration window of the port the GPI1600 is connected to.

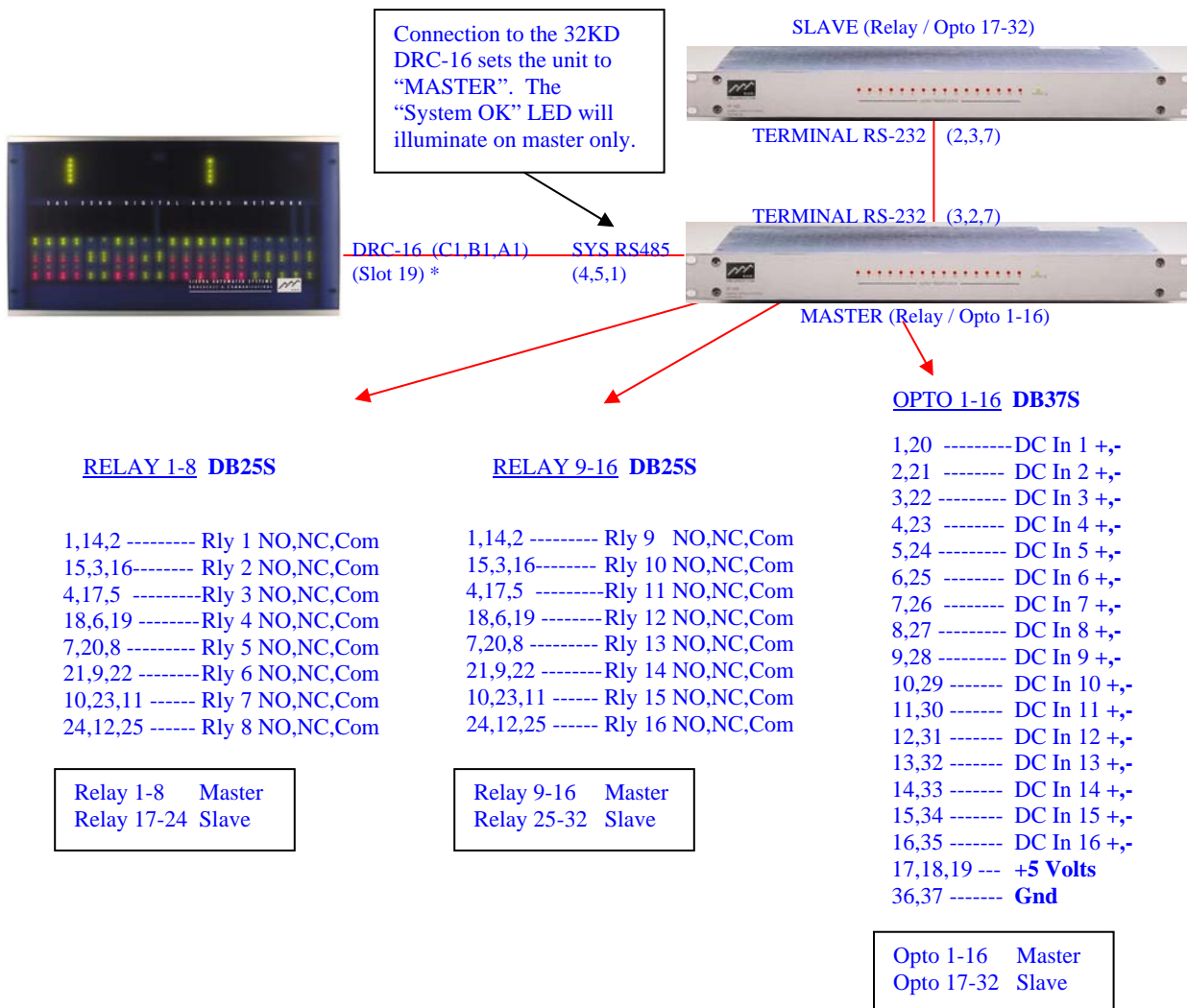



GPI-1600 Opto/Relay Programming

The RCS control software screen as follows is used to configure and assign the opto and relay functions. Each RS-485 control port can support 32 opto inputs and 32 relay outputs which are two (2) GPI-1600 slaved together. The Master GPI1600 represents Opto/Relay 1-16 and the slave represents Opto/Relay 17 to 32. The configuration also is used to define the absolute relay number block since any of the DRC-16 control ports can be connected to GPI-1600 controllers for applications requiring more than 32 Opto/Relay channels.

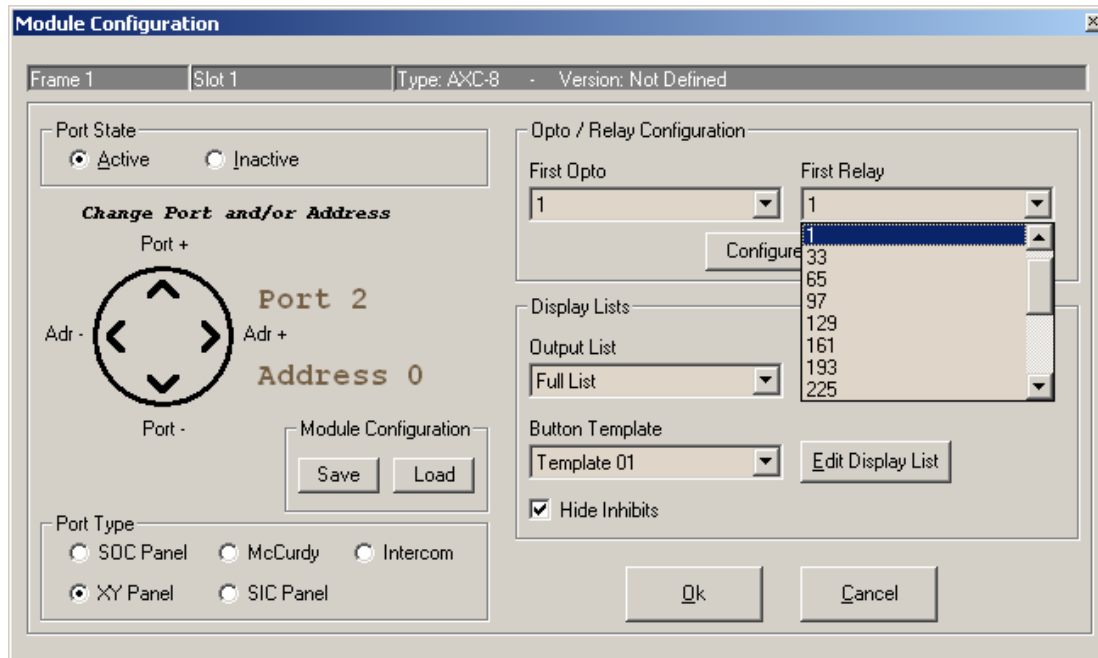

When the “Port Type” selected is “XY Panel” the window will display “Opto/Relay configuration” in the upper right corner. Using the pull down lists each GPI-1600 panel (or AXC-8 optionally fitted with opto inputs and relay outputs) must have the first relay number and first opto number defined. Each control port address can support up to 32 relays and the start of each block is selectable from the pull down lists. If the opto/relay block is assigned to another port/address, then the system will display a message window “Channel Conflict” indicating that the block of opto/relays are currently assigned to another Port/Address panel.

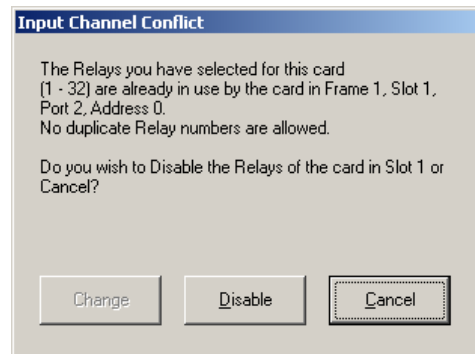

Once opto and relay numbers are assigned clicking the “Configure Relays” button (upper right corner) will open the following window.

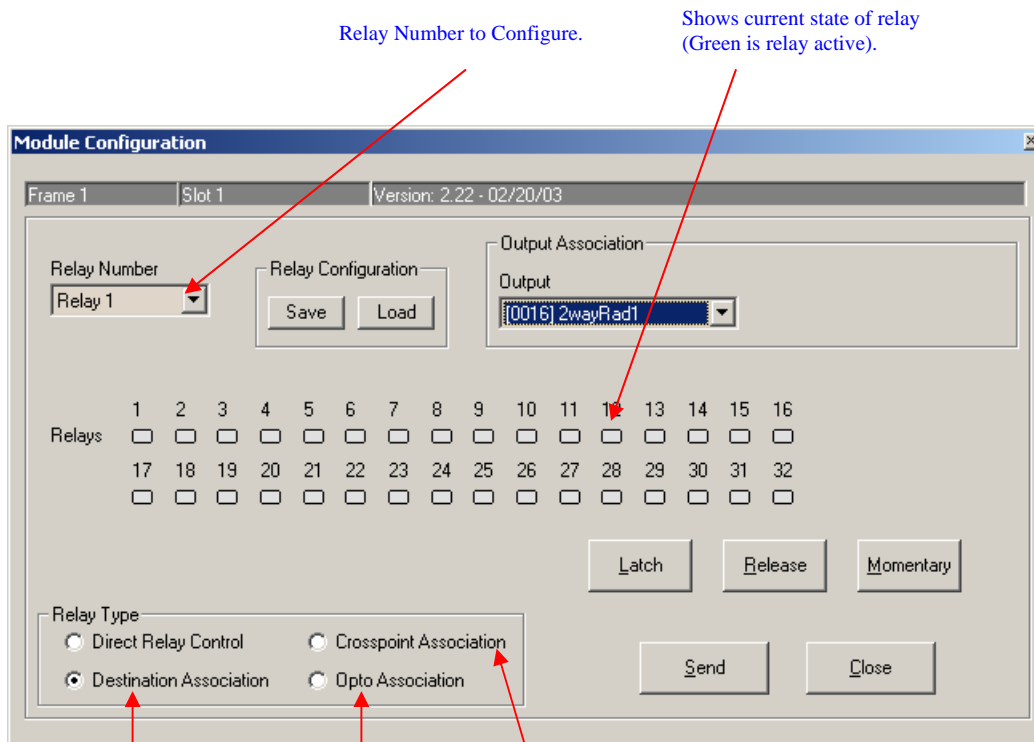

Relay Number to Configure.

Shows current state of relay (Green is relay active).

Relay will activate on any source selected to the assigned output

Relay will activate on Assigned Opto Activated.

Relay will activate on Assigned Input Selected to Assigned Output.

“Relay Type” allows 4 options as shown. Direct Relay Control allows the “Latch”, “Release”, or “Momentary” window buttons to immediately actuate the relay as selected in the “Relay Number” window. Other options allow the relay to be assigned to an opto to allow DC control routing or to a switcher mapping of audio as shown above. Opto to Relay mapping can also be accomplished using an automated event line in the optional Automation Software module.

When editing of the relay function is complete, the “Send” button must be clicked to send the relay assignments for this control port and address to the system. Note that the AXC-8 XY panel can optionally be fitted with relays and opto inputs. This example shows that relay 1 will activate when any source is selected to output 16 (2 way radio) and this can be used as a “Key” control for a two way radio.



Intercom and IFB Feature

The SAS 32KD system provides a control layer that allows a complete intercommunications function and IFB (interrupted fold back) to selectable system outputs. The “Priority Take” function allows a source (defined as Mic or IFB source) to be switched to an output replacing the previously selected audio for the duration the button on the SAS controller is pressed. When the button is released, the previously selected source is “restored” to that output giving an IFB type action. Buttons on the controllers can be individually programmed as “Priority Take”, (TALK) function, or as a regular switcher TAKE function (LISTEN). All SAS controllers can be used for “control only” intercom and IFB functions and is suitable for use in locations where Mic and Speaker utility already exist. (IE control room with console).

RCS-16 Control Panel Wiring

The RCS-16 is a 2 RU chassis that provides a self contained Mic (and Mic pre-amp for line level out) and Speaker for stand alone intercommunications functions. The RCS-16 provides an 8 character alpha numeric display with rotary dial to select the “destination” (output) to communicate to. Additionally the panel provides 16 (or 8 for RCS-8 model) programmable buttons for instant “talk to destination” capability. The buttons also can be programmed to “listen” to any source of the switching system. Each RCS-16 full function controller requires 3 signal wires; Input (Mic), Output (Speaker) and control line. Each signal is balanced differential and can be three individual shielded pairs, or a single CAT V cable of which only 3 of the 4 pairs would be used for signal. The last pair can be used for the signal ground. The RCS-16 panels connect to the system as follows. The RCS series now allows expanded address access to eight. See RCS table above in Control panel configuration for all eight (8) address pin and jumper installation.

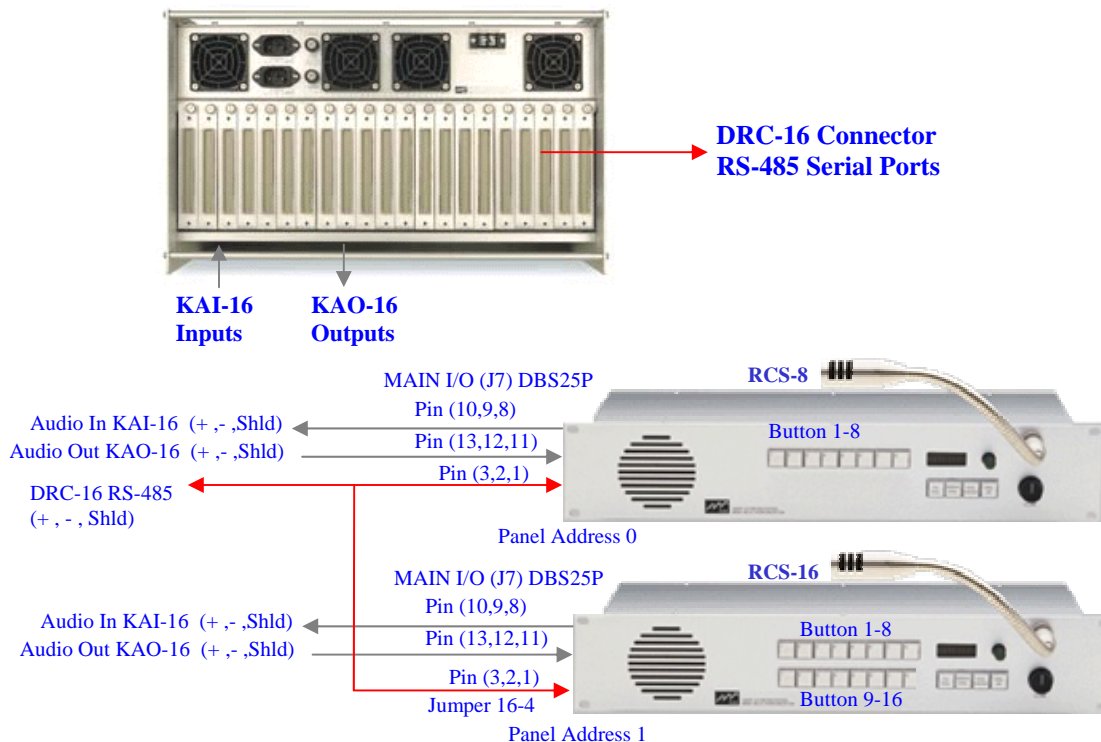



Intercom and IFB Feature

APC-88 Control Panel Wiring for Intercom

The APC-88 provides an intercom function “Control Only” for applications in a control room where microphone and speaker facilities already exist. The APC-88 is designed as a console drop in module and needs to be set using a jumper to operate as an intercom controller. The APC-88 will default operation as a Switcher controller if no jumper is installed. Wiring the RS-485 serial port and address jumper using on the 9 pin D connector is the same as shown on previous pages. Listen audio (from the system) and Talk audio (to the system) will come from the audio console. Typically, the microphone audio processor output is bridged to an input of the 32KD system for station MIC or TALK audio. Similarly, the Cue speaker EXT input of the audio console(or control room monitor EXT input) is fed from an output of the 32KD for station SPEAKER or LISTEN audio. Each station MIC and SPEAKER channels of the 32KD system are assigned using the RCS software as shown on the next page. The APC-88 connects to the system as follows:

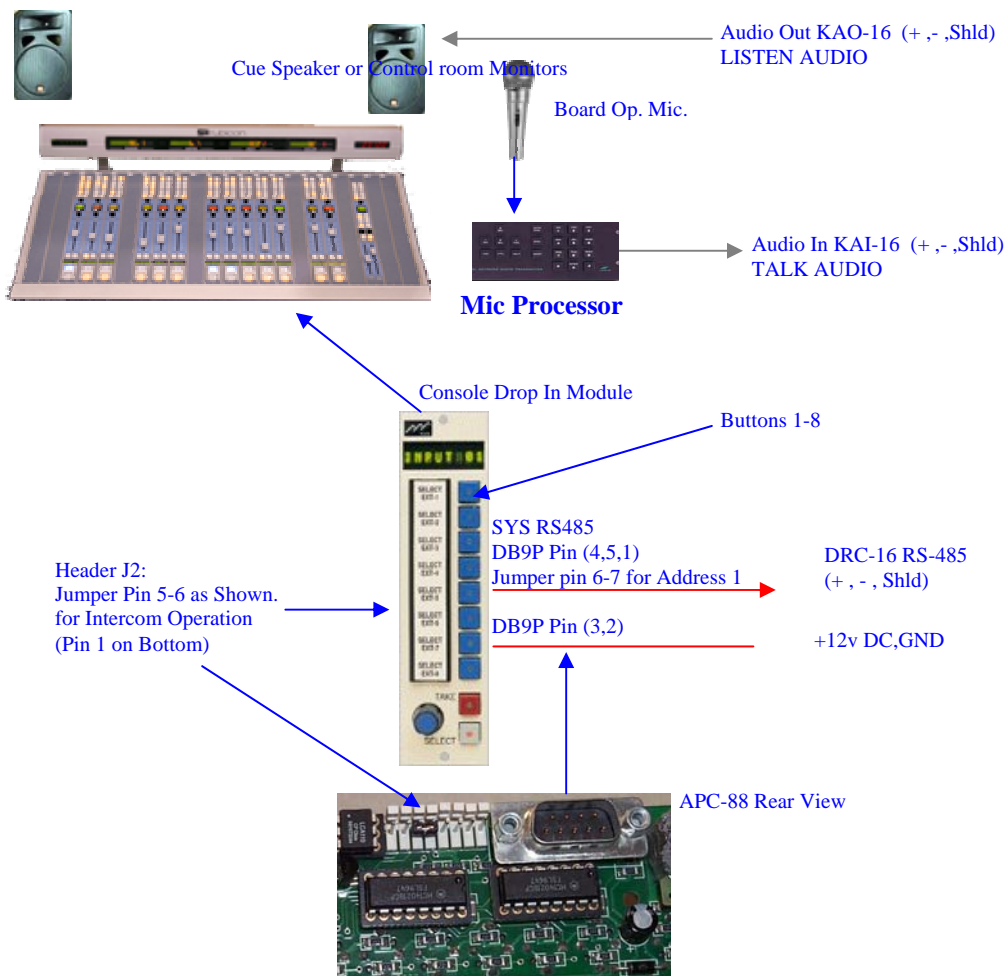



Intercom Station Programming

The RS-485 control port on the DRC-16 that connects to the controller for intercom function has to be programmed for “Intercom Port Type”. This makes the control port for all panel addresses (panel 0 and panel 1) operate as intercom and will cause the buttons to operate as push to talk action. When the port type is selected as Intercom the window provides options to select the switcher Input for the Intercom Station Mic, and switcher Output for the Intercom Station Speaker. From the Switcher Status/Configuration folder click the “Config” button on the DRC-16 slot that the controller is connected to. Select the control port to Edit and this will bring up the following window for control port editing.

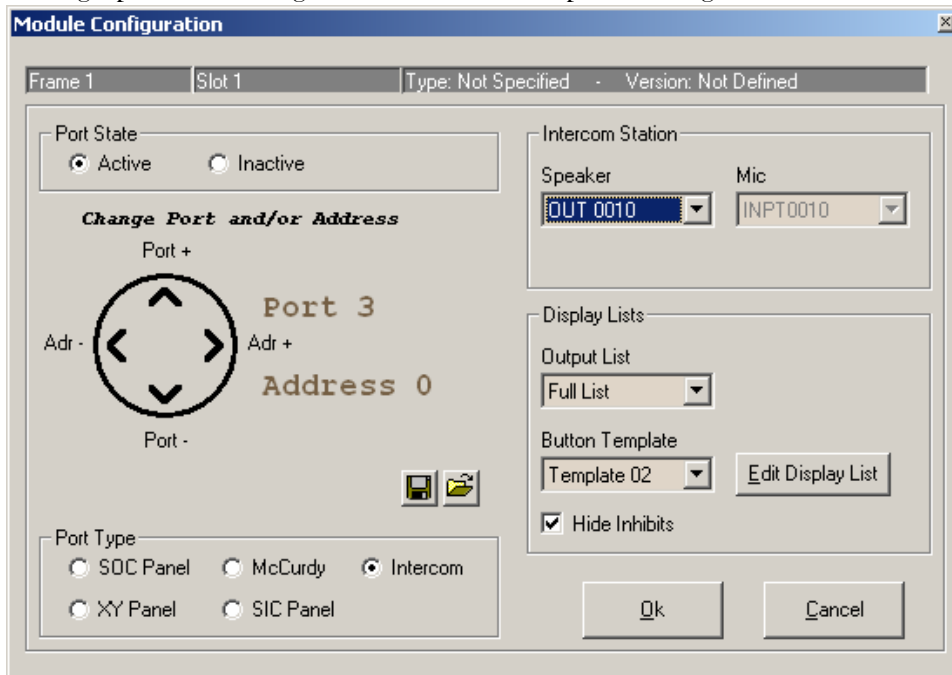

This window provides the pull down lists for the switcher outputs and inputs making selection of Mic and Speaker easy. Also utilizing pull down list options, each station can be programmed to use a specific Output List to allow only SELECTED OUTPUTS to be included in the alpha numeric dial up directory. This list should only include switcher outputs assigned to other intercom station speakers, (Intercom function both ways creating a 4 wire intercom) and other switcher outputs that are to have IFB (Outputs feeding remote channels such as Telephone lines, ISDN/T1 Codecs etc.). Similarly, the buttons can be programmed for talk and listen functions as described below. The button program template (or list) allows for 64 buttons to accommodate all SAS pushbutton control panels. When connecting controllers with 8, 16 or 32 buttons, the remainder of the buttons on the template are simply ignored. The system allows 256 different button programming templates where any template can be assigned to any panel independently. Utilizing this template scheme can reduce the amount of work for programming button assignments when numerous panels require the same button assignments. (IE Intercom group, REMOTE Fader Group, CODEC group etc.)



Button Templates and Programming.

It is recommended to handle the templates as distinct groups. IE Intercom group, Console Remote Group, etc. This makes managing the templates easier. The templates are programmed from the main window “Button Programming” folder. The following window will appear. The Template name and number appear in the window and using the window tabs navigates to the different sections of buttons. All switcher type control panels (SOC) have to be set as LISTEN allowing switcher sources to appear for list of options. These buttons function as push on/push off action as well as “interlocked”. (Select new source, remove the previous).

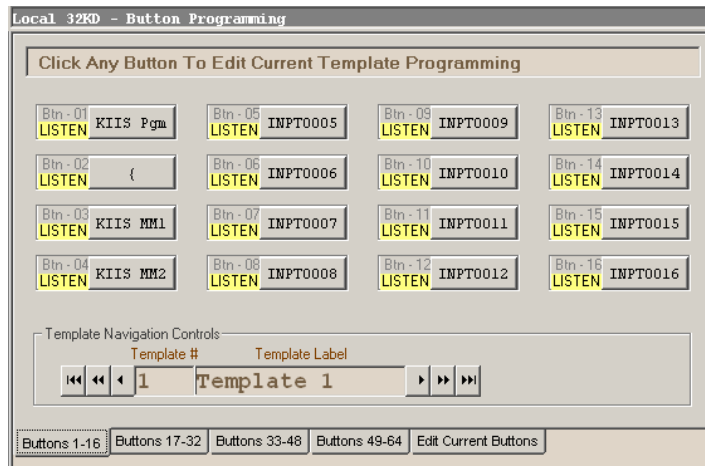

To edit a button, click on the Edit Current Buttons tab or simply click on the button Box. The following options will appear. Using the Button type options and pull down lists the button can be programmed to a single output (if talk) or a group of outputs.

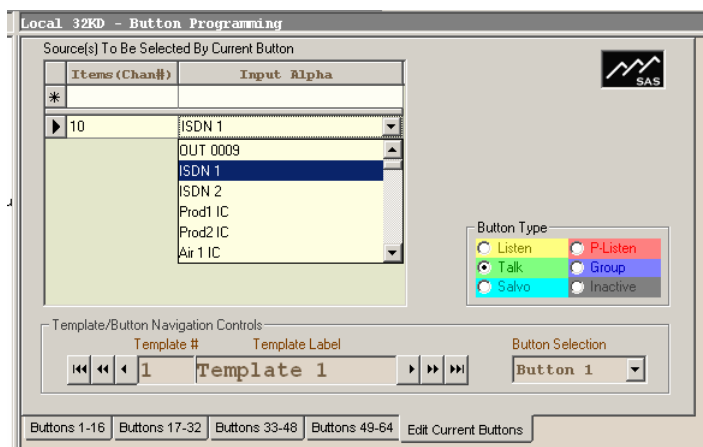

Note: if the controller is a SOC type then the button type must be set for LISTEN and the pull down list will show switcher inputs for source selections.

The LISTEN button type can also be used for INTERCOM controller useful for turning on an input to monitor, such as Two Way Radio. The LISTEN button on the intercom control panel (RCS type) will always function as a push on/push off action. An example of a typical application for Intercom Listen is communications to a two way radio. A Two Way Radio does not have the means to select an intercom station to speak to. When talking to an output that is a Two Way Radio, a LISTEN button is used to hear the two way radio response when needed. Note that any intercom station that has a LISTEN button assigned and turned on will hear the Two Way Radio. Additionally, a relay as previously described, can be programmed to activate (Key) the Two Way Radio when any station is talking to the Two Way Radio output. (any source selected to the output actuates the relay.) When the button assignment is complete simply click on the Buttons Section tab or use the pull down option to edit another button. The Button Section window displays the button functions in a color coded manner for quick at a glance intuitive presentation of the template. Below is a typical button template for a Radio Studio application. In this example, button 7 can call the ISDN group, and Button 8 calls the Production rooms group. Button 5 is TALK to Two Way Radio 1 and physically (on the RCS-16 panel) below button 5 is button 13 to LISTEN to Two Way Radio 1. Same for Two Way Radio 2. Therefore TALK is on top, and LISTEN is on the bottom allowing a user friendly layout for the operations personnel. This template can now be labeled and can be assigned to each individual intercom station controller as described above.

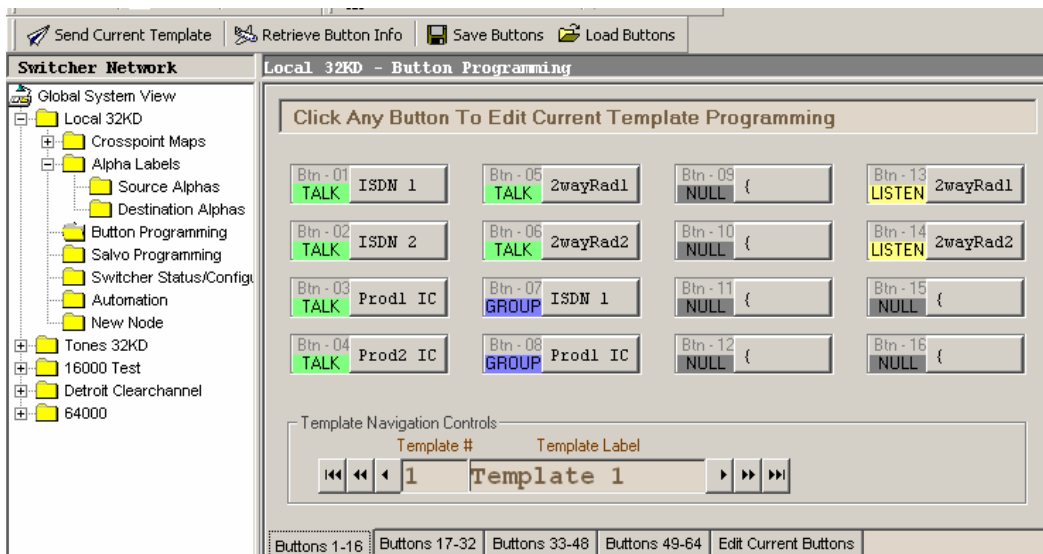

When editing the pushbuttons is complete, this set of button templates must be sent to the system using the “Send Current Template” button on the top left of the window. Also the template programming can be saved and retrieved for applications where the button assignments may change dynamically based on a timed event with the optional Automation Software Module.